

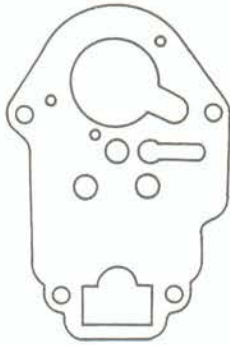

GUARNIZIONI



COPERCHIO VASCHETTA CARBURATORI WEBER VETTURE ITALIANE



7071
28 ICF/30 ICF

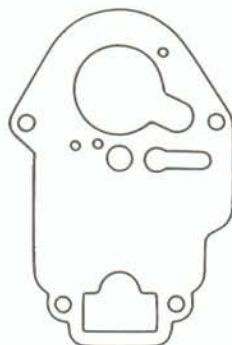

7867
30 ICF 21

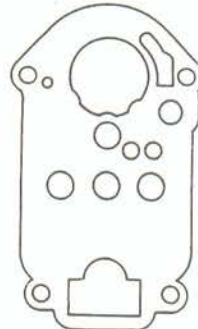

7072
26 IM-1

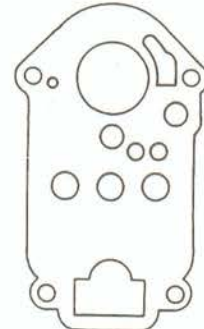

7072 B
26 IMB 4-5

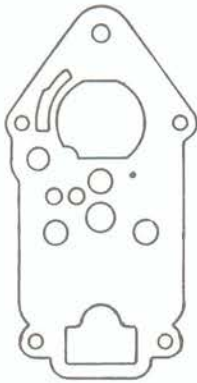

7520
24 IMB 1/100
28 IMB 1/100

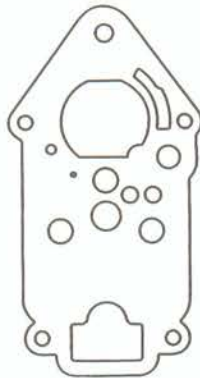

7714
28 IMB

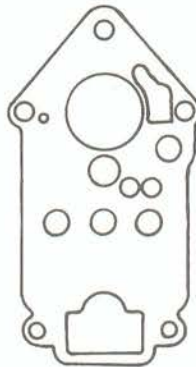

7327
26 IMB 6/11

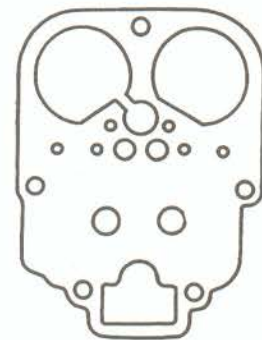

7180
30 DIC

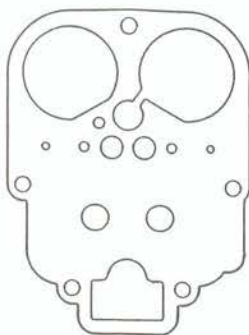

7517
30 DGF
Panda 30 - 126 Bis

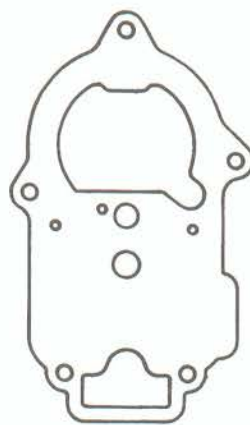

7373
32 ICEV u.t.

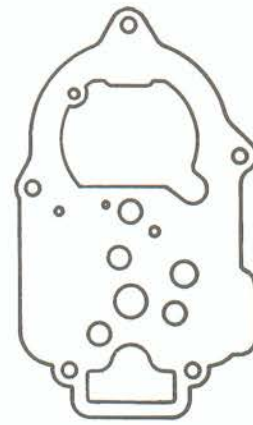

7379
32 ICEV



COPERCHIO VASCHETTA CARBURATORI WEBER VETTURE ITALIANE

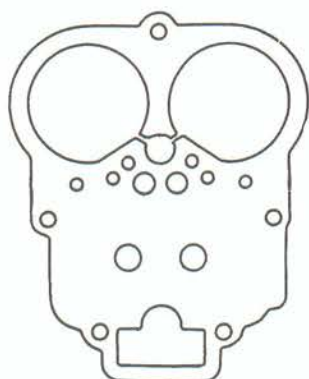

7216
32/34 DHS

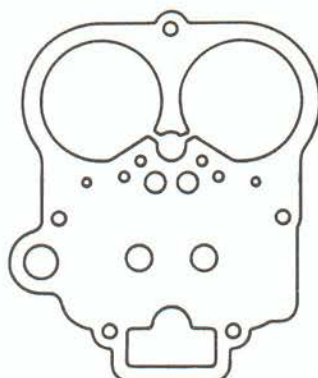

7326
32/34 DHS

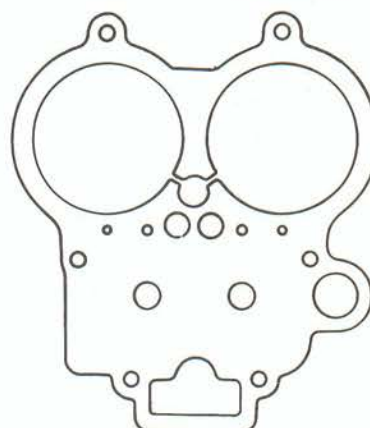

7428
42 DFC-1
45 DFC

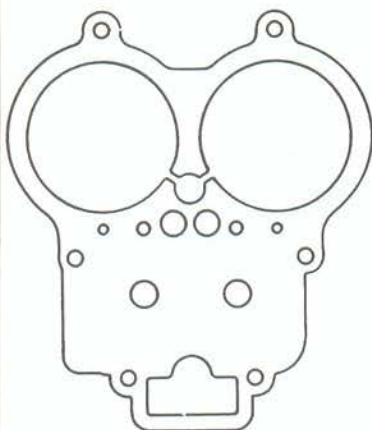

7404
42 DFC

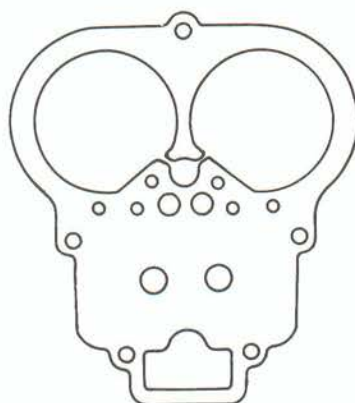

7410
40 DFI 5/6

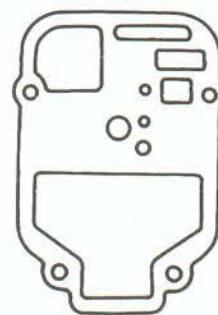

7264
32 OF

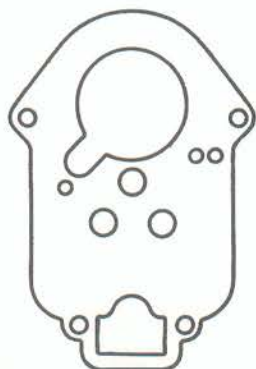

7201
32 IMB

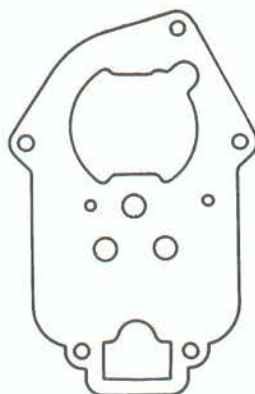

7674
32 IBS

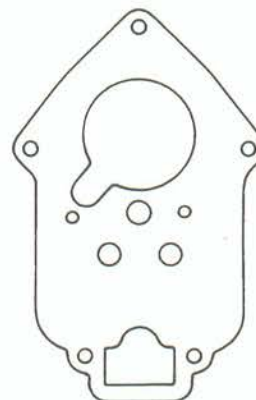

7398
32 IBA



COPERCHIO VASCHETTA CARBURATORI WEBER VETTURE ITALIANE

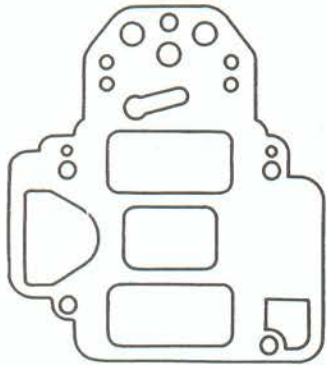

7118
40 DCOE

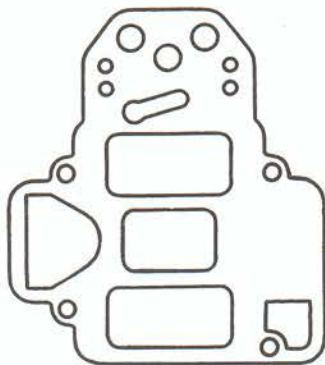

7184
40 DCOE u.t.

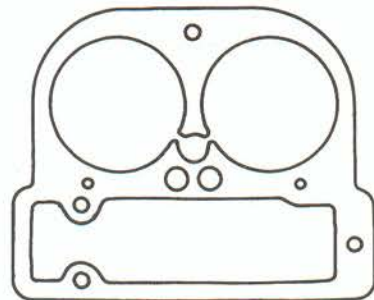

7315
40 DCN

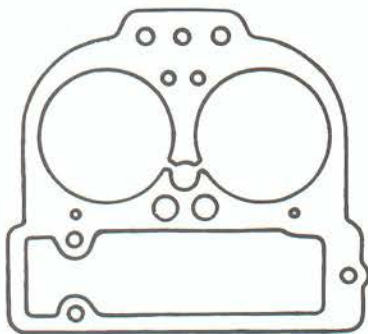

7370
40 DCNF

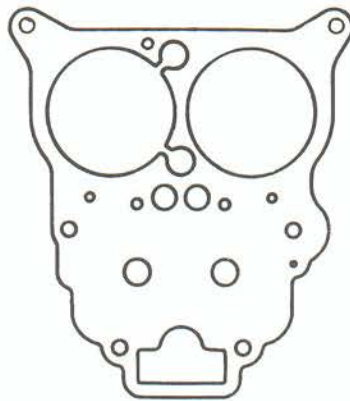

7619
32 ADF 3/200

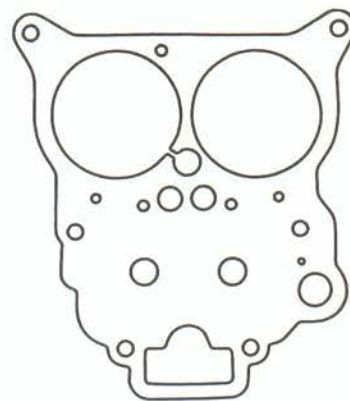

7698
32 ADFA 3/100

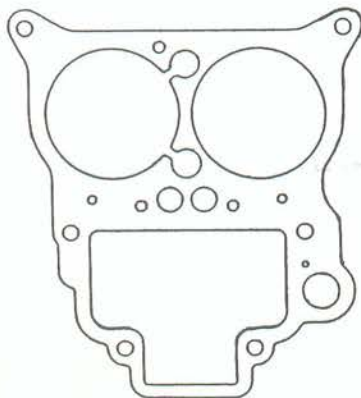

7975
34 ADM

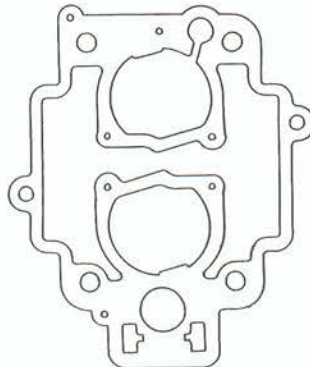

7984
32/34 TLDA - 32/34 TLDE
Lancia Delta - Prisma
Fiat Ritmo 75 - Regata

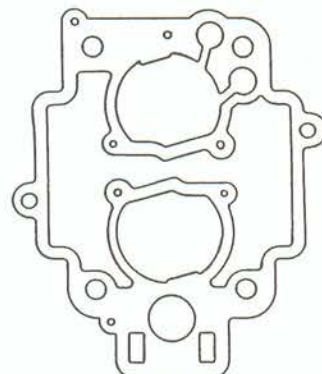

7999
32/34 TLDE 4/150 - 32/34 TLDM
Fiat Croma 2000 CHT
Fiat Tipo 1,4 Digit - 1,6 Digit



COPERCHIO VASCHETTA CARBURATORI WEBER VETTURE ITALIANE

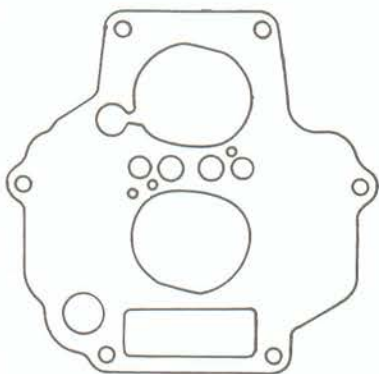

7424
32 DMTR

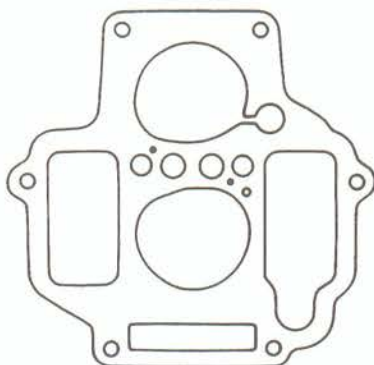

7453
32 DMTR

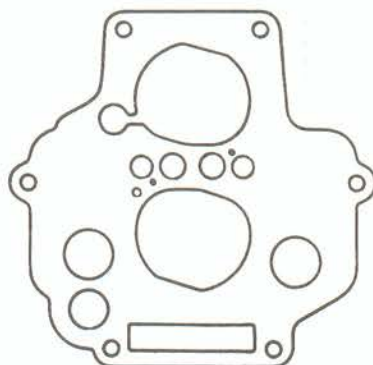

7606
32 DMTR
128 Rally - Abarth

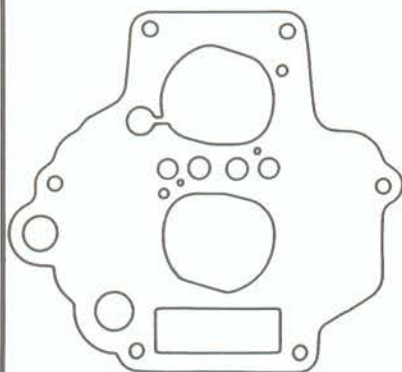

7626
32 DMTR/200

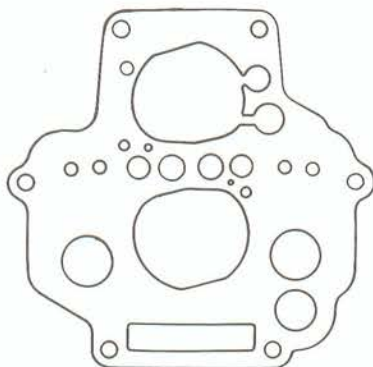

7902
32/34 DMTR 88/100
Fiat Regata 85 S
Fiat Ritmo 85 S

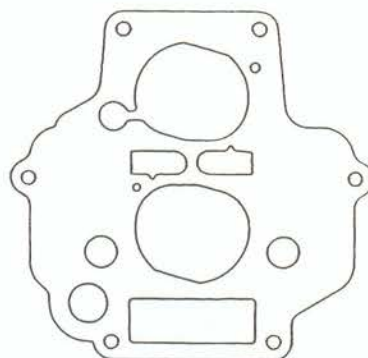

8097
32/34 DMTE
Fiat Uno CS - Duna 70

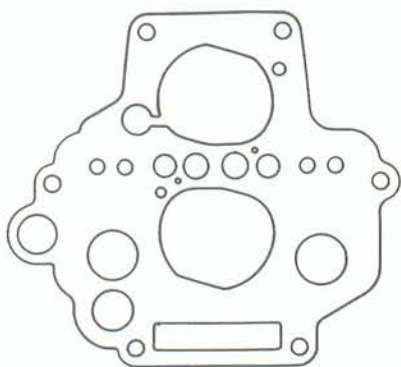

7865
34 DAT 13/50
Lancia Delta 1600 - Lancia Prisma

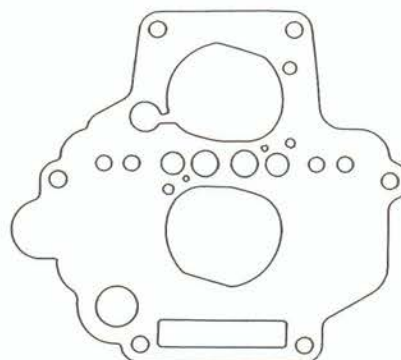

7973
32 DAT 18/250
Lancia Delta HF 1600 cc.



COPERCHIO VASCHETTA CARBURATORI WEBER VETTURE ITALIANE

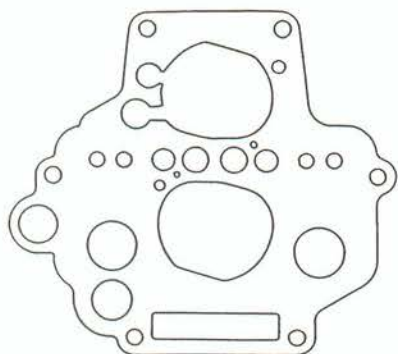

7980
34 DAT 54/250
Fiat Croma CHT 2000 cc.

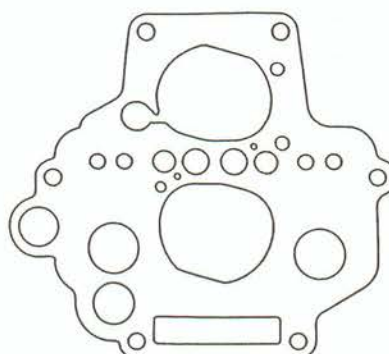

7982
34 DAT 23/150 - 28/350
Maserati Biturbo 420 - 425

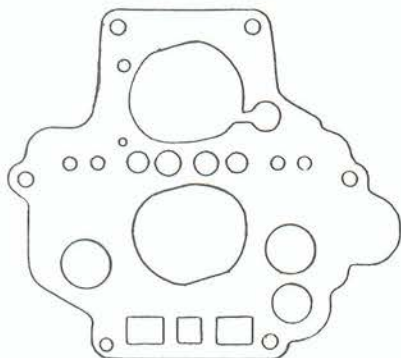

7986
30/32 DMTE
Autobianchi Y10 Turbo

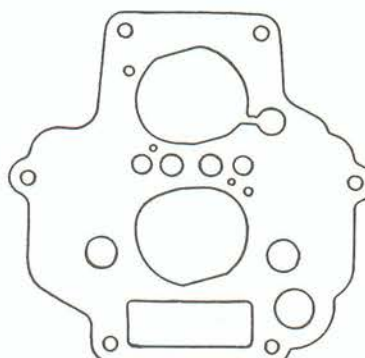

8057
30/32 DMTE 27/150
Fiat Duna 60/70

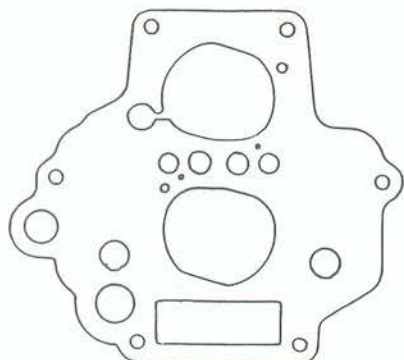

8100
32/DMTR
Lancia Delta 1500

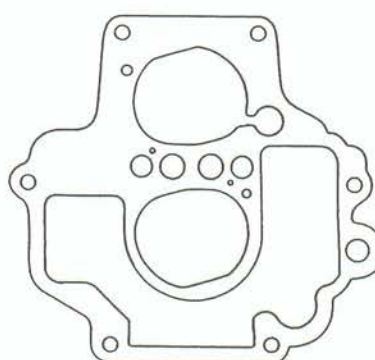

7987
30/32 DMTE - 34 DRTC
Fiat Regata E.S. - Citroën BX19 - Peugeot 305 - 309



COPERCHIO VASCHETTA CARBURATORI WEBER VETTURE ITALIANE

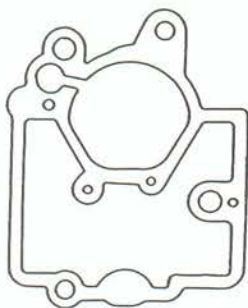

7943
32 TLF
Autobianchi Y10 Fire
Fiat Uno 1000 Fire

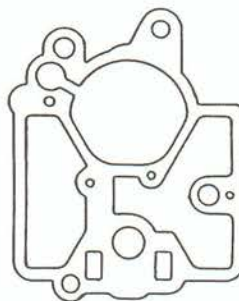

7983
32 TLF - 36 TLP - 36 TLC
Autobianchi Y10 Fire - Peugeot 309
Peugeot 205 1600 cc.

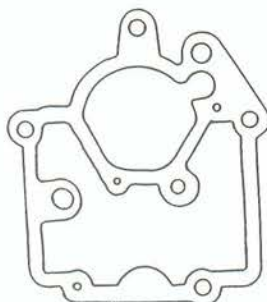

8053
32 TLF
Autobianchi Y10 Fire
Fiat Uno Fire

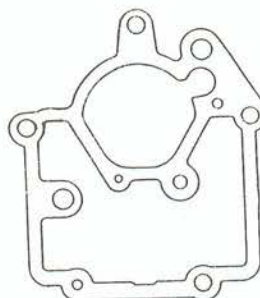

8110
32 TLP
Peugeot 205

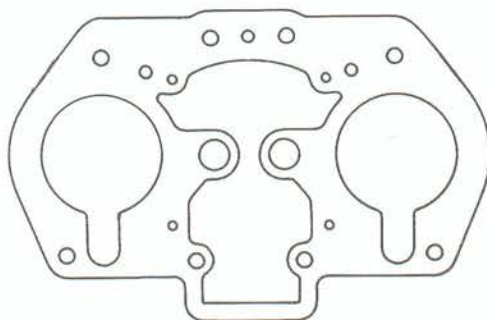

7399
40 IDF



COPERCHIO VASCHETTA CARBURATORI WEBER VETTURE ITALIANE

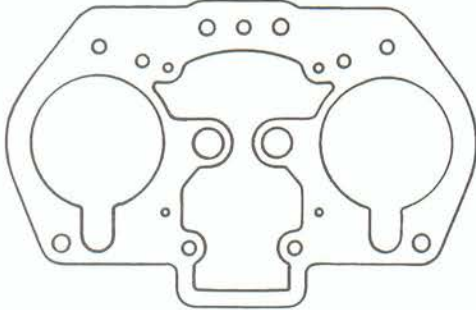

7559
42 IDF
124 Abarth - Rally

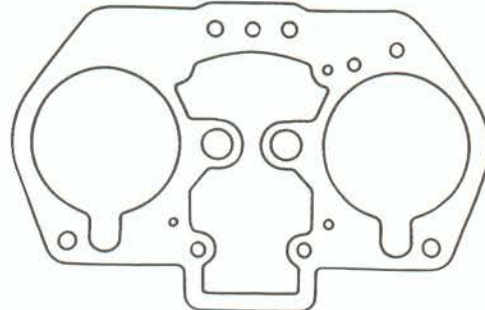

7743
Weber 48 IDF

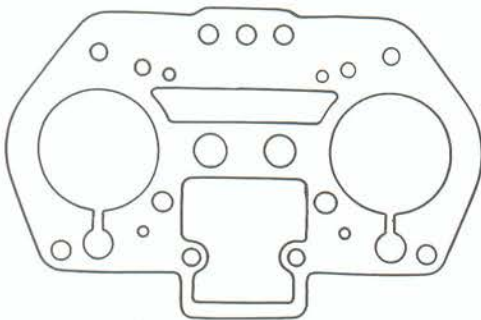

7788
36 IDF 44/45
Alfasud Sprint 1360/1500 cc.

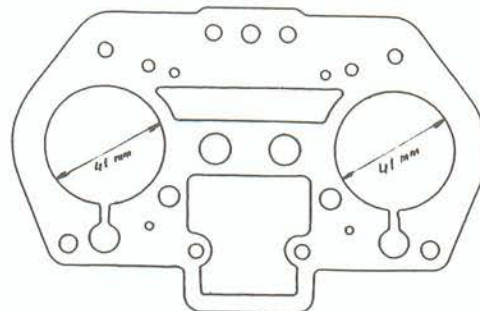

8098
40 IDF
Alfa 33



INTERNE CARBURATORI WEBER TIPI ITALIANI

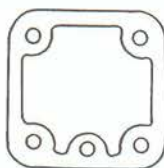

8095
40 DCOM



7119
40 DCOE

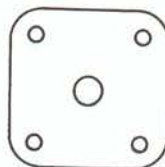

7415
40 DCOE

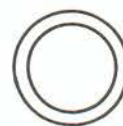

7008
40 DCOE



7120
40 DCOE



7332
32 DHS



7229
34 DHS



7582
32/34 DHS

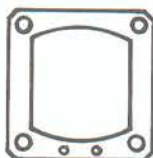

7380
32 DCOF



7248
32 OF

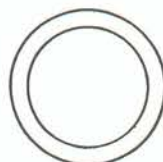

7405
32 ADF



7228
34 DCHE



7703
40 DCNF



7365
32 OF



7959
32 TLF



8056
32/34 DMTE
Fiat N. Ritmo 75



COPERCHIO VASCHETTA CARBURATORI SOLEX VETTURE ITALIANE

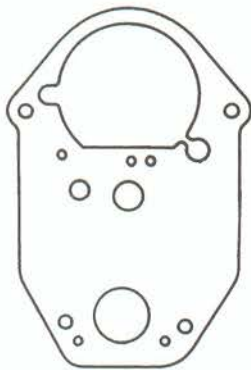

7393
32 DISA

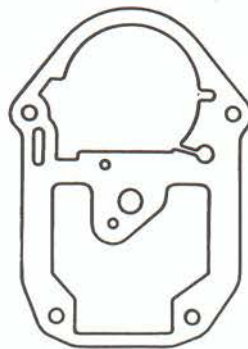

7623
32 DI-2

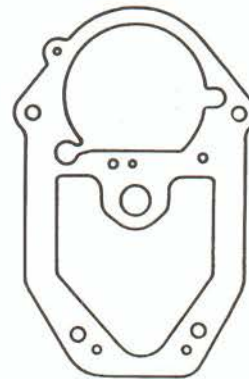

7624
32 TDI-2

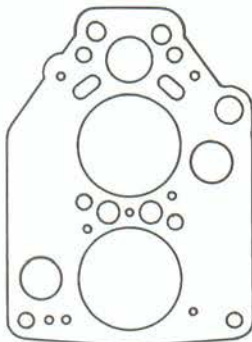

7853
30/32 CIC
Citroën CX

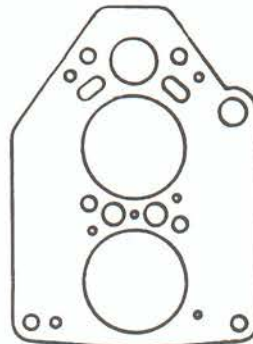

7555
32 CIC

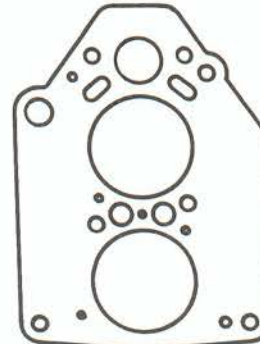

7621
34 CIC

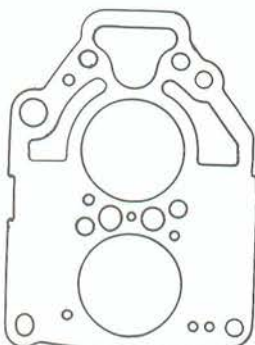

7886
34 CIC
Fiat Ritmo 75

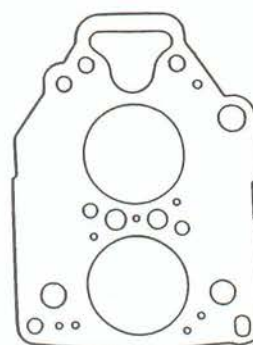

7994
30/32 CIC 11-13-14-30 CIC 1
Fiat Uno 60L - SL - Nuova Ritmo 70
Ritmo 60 E.S. 1100 cc.
Regata 70 Eur.

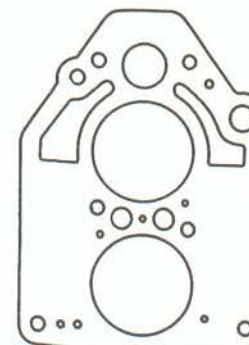

7656
32 CIC-2
34 CIC



COPERCHIO VASCHETTA CARBURATORI SOLEX VETTURE ITALIANE

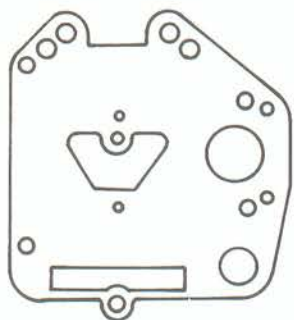

7266
40 DDH

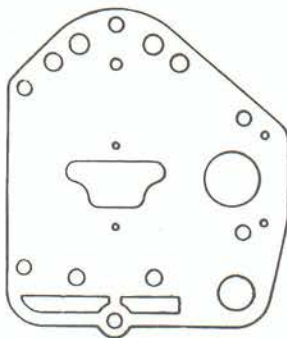

7551
40 DDHE 1

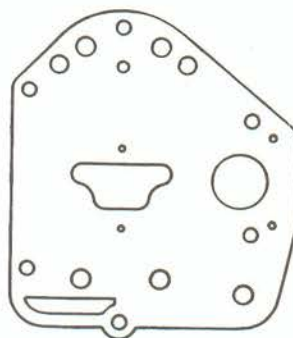

7552
40 DDHE 6

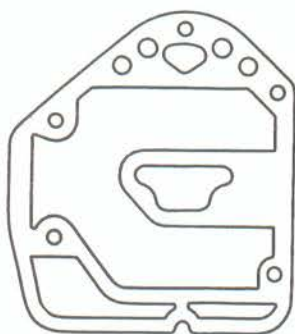

7627
40 ADDHE
Alfa Romeo

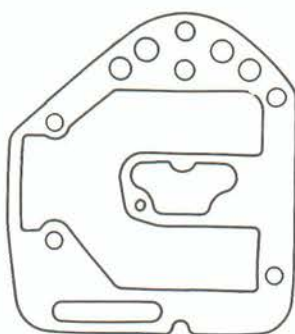

7832
40 ADDHE 32
Alfa Romeo Giulietta 1,8

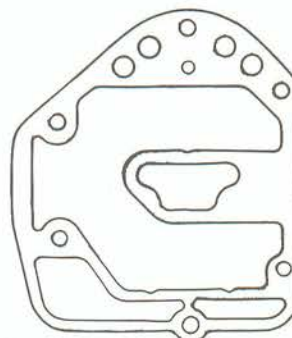

7909
40 ADDHE
Alfa Romeo Giulietta 1,6 - 1,8 - 2,0

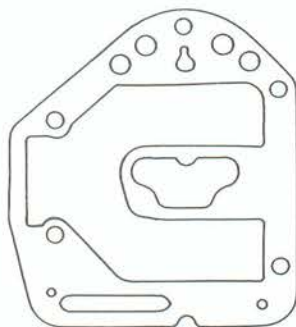

7976
40 ADDHE
Alfa Romeo

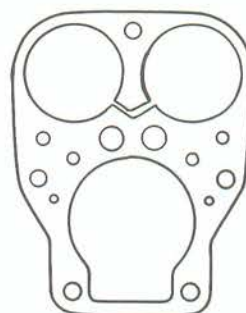

7792
30 DID
Fiat Panda 30



COPERCHIO VASCHETTA CARBURATORI SOLEX VETTURE ITALIANE

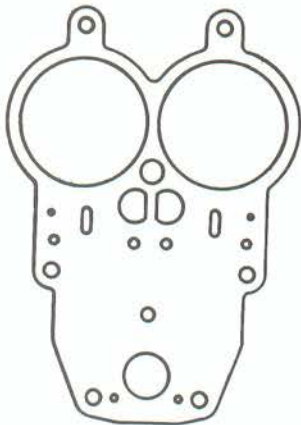

7363
32 EIES

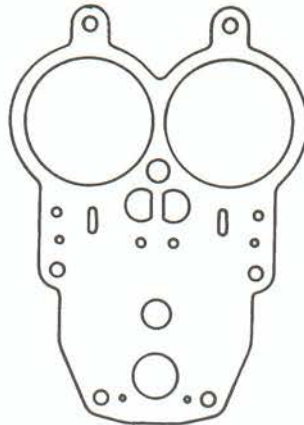

7514
34 EIES

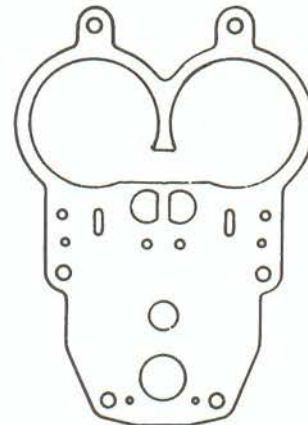

7522
36 EIES

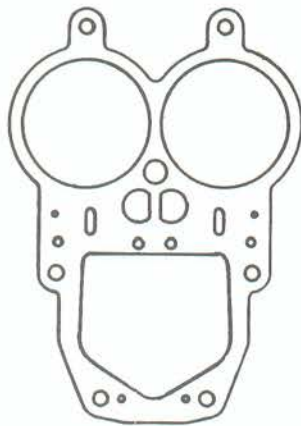

7595
32/34 EIES

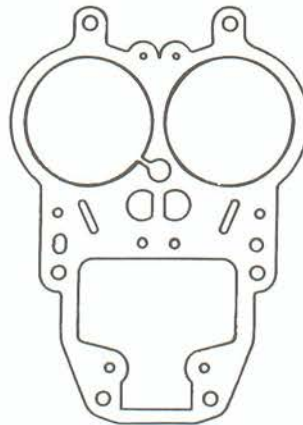

7654
32 TEIE

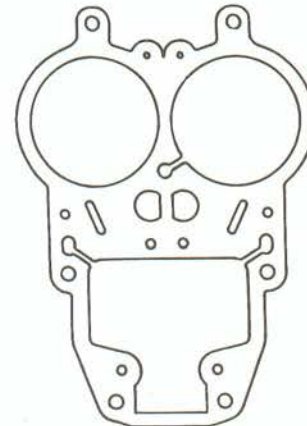

7713
34 TEIE

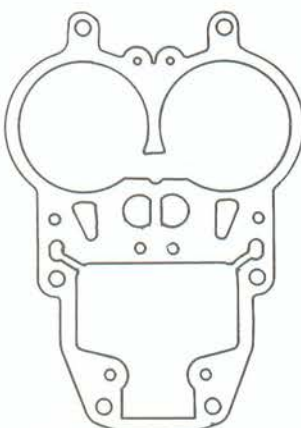

7870
32 TEIE 7
Fiat 131 Supermirafiori - Fiat 132

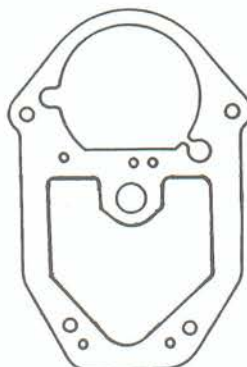

7594
32 DISA 21

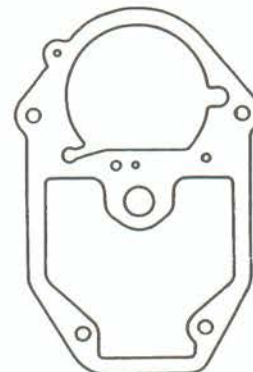

7754
32 DISA 1/2
34 DISA 3



COPERCHIO VASCHETTA CARBURATORI SOLEX VETTURE ITALIANE

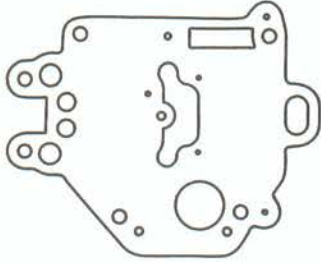

7680
32 PHHE-1

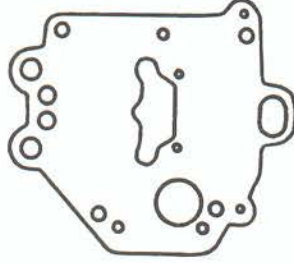

7191
32 PHH

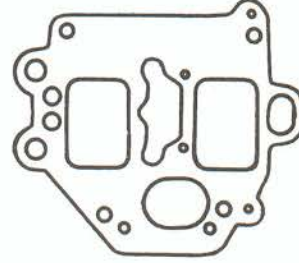

7192
32 PHH

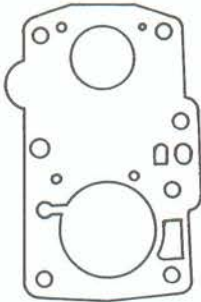

7210
30 PIB-4

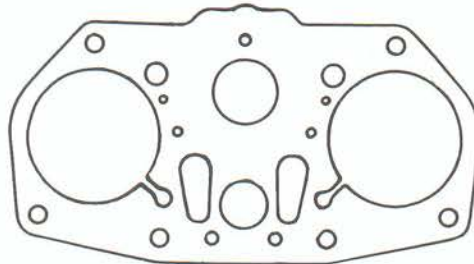

7435
40 PII 6

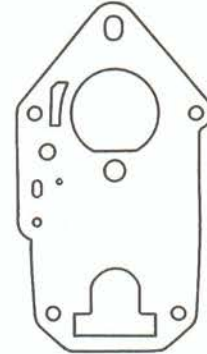

7652
28 ID



7159
32 PBIC u.t.

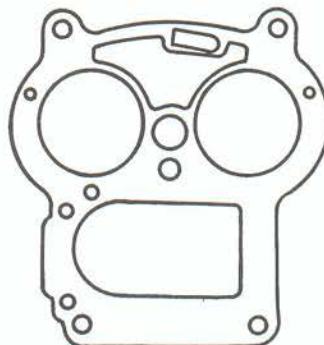

7160
32 PAIA



7361
34 PAIA



INTERNE CARBURATORI SOLEX TIPI ITALIANI



7198
32 PHH

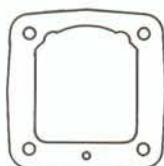

7924
40 ADDHE
Fiat Ritmo 130 TC

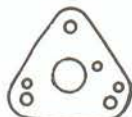

7396
32 EIES



7397
32/34 EIES



7364
32/34 EIES



7831
40 ADDHE 32
Alfa Romeo Giulietta 1,8

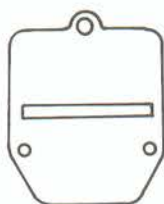

7247
40 DDH

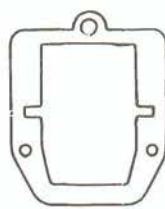

7550
40 DDH



7553
40 DDHE



7678
32 DIS 40

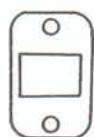

7209
32 PHH



7246
35 PHH



7212
32 PAIA



7150
32 PAIA

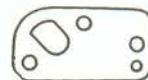

7556
32 CIC



7292
32 CBI



7109
35 APAIG



7101
32 PBIC
32 PAIA



7395
32 DISA



7521
36 EIES



7103
32 PBIC



INTERMEDIE WEBER E SOLEX ITALIANE

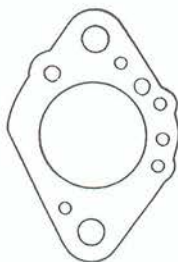

7372
32 ICEV
Fiat 128 - Ritmo

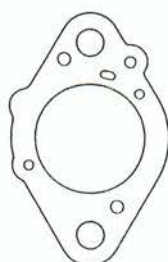

7394
32 DISA
Fiat 128 - Ritmo

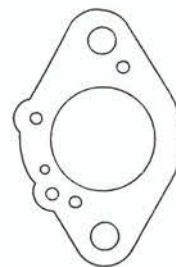

7673
32 IBS
Alfa Romeo Alfesud

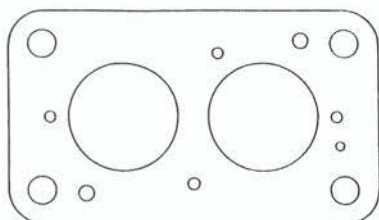

7625
32 ADF
Fiat 131 1300 - 1600

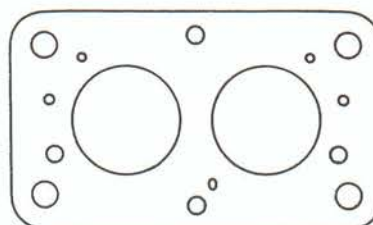

7653
34 TEIE
Fiat 131 1300 - 1600

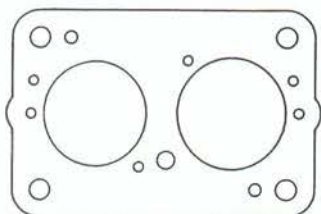

7988
32/34 TLDA - 32/34 DMTL
Fiat Tipo 1,4 Digit - 1,6 Digit - Land Rover

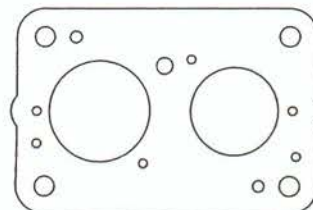

7989
28/32 TLDM
Lancia Delta - Prisma
Ford Escort Orion 1,6 1597 cc.
Ford Orion 1,4 - Ford Fiesta 1,4
Ford Fiesta XR2

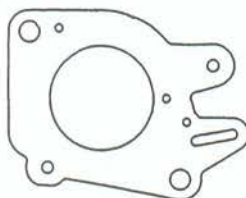

7944
32 TLF
Autob. Y 10 Fire - Uno Fire



COPERCHIO VASCHETTA CARBURATORI DELLORTO

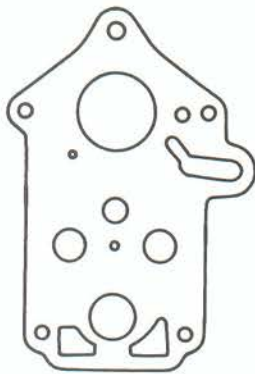

7322
FRG 28

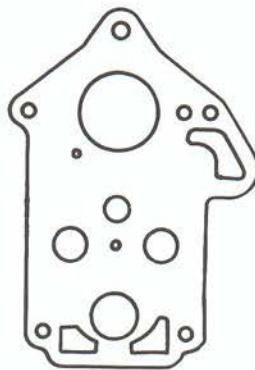

7331
FRG 28 u.t.

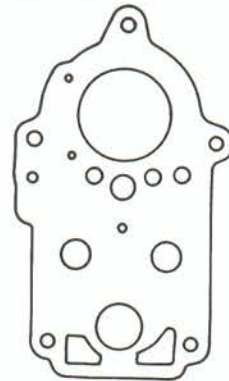

7321
FRD 28

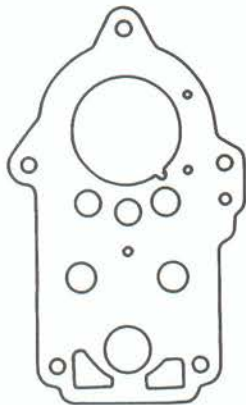

7320
FRD 32

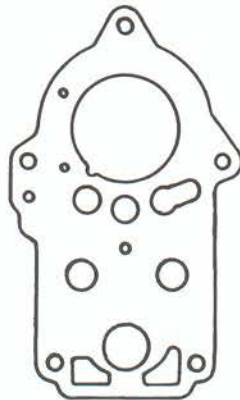

7330
FRG 32 u.t.

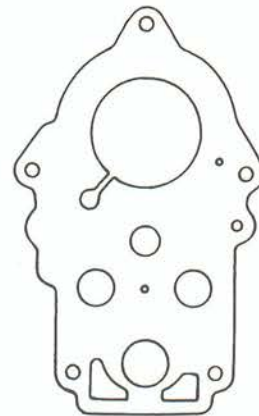

7531
FRDA 32 E

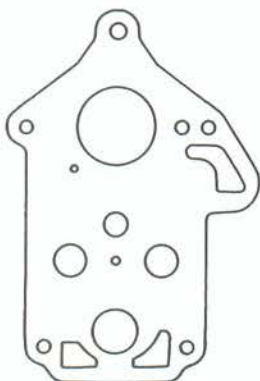

7655
FGRB 28

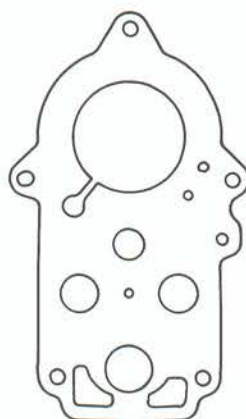

7793
FRDC 32
Fiat 127 - A 112

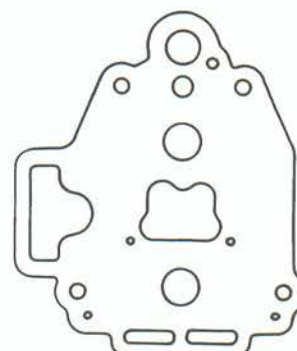

7429
32 DHLB



COPERCHIO VASCHETTA CARBURATORI DELLORTO

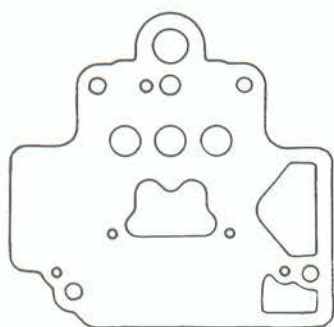

7387
40 DHLA

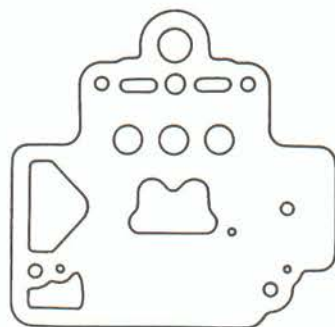

7672
40 DHLA

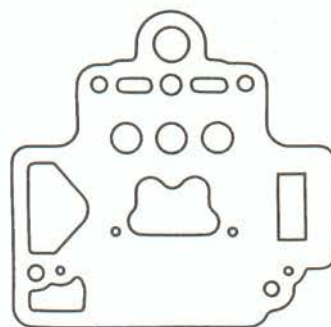

7725
40 DHLA

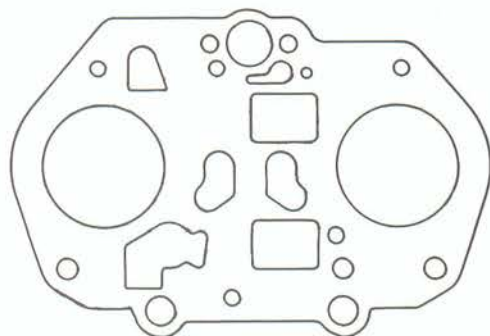

7833
36 DRLA
Alfa Romeo Alfasud T1 - Alfasud Sprint

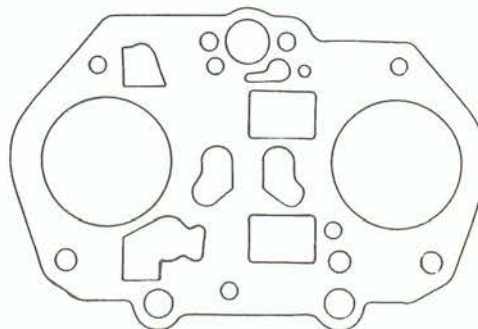

8014
40 DRLA
Alfa Romeo Alfa 33 - Alfa 75

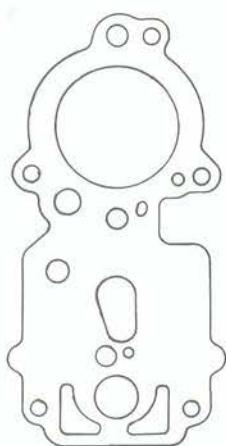

7857
40 FRPA
Alfa Romeo Alfa 6



7319
F Z D



INTERNE CARBURATORI DELLORTO

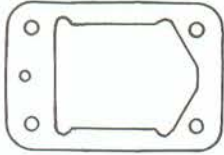

7431
32 DHLB

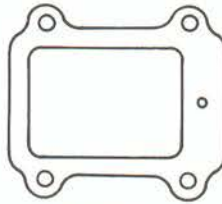

7417
40 DHLA

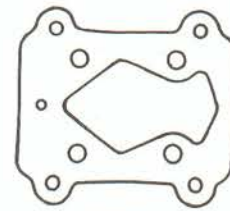

7671
40 DHLA



7388
40 DHLA



7430
32 DHLB

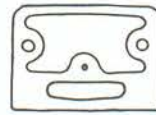

7889
40 DHLA
Alfa Romeo 1750
Alfetta



7804
40 DHLA
Alfa Romeo
Giulietta 1,3 - 1,6

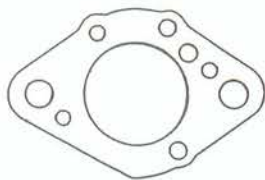

7532
FRDA 32

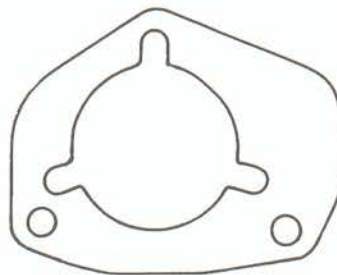

7491
FRD 32

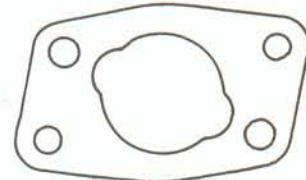

7492
F Z D

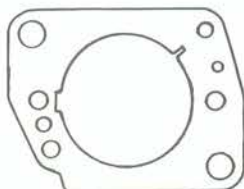

7920
40 FRPA
Alfa Romeo Alfa 6

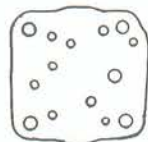

7919
40 FRPA
Alfa Romeo Alfa 6



7533
FRDA 32 E

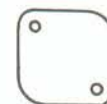

7490
FRD 32



ATTACCO FILTRO CARBURATORI DELLORTO

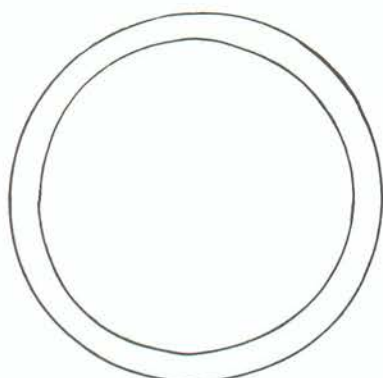

7586
F Z D

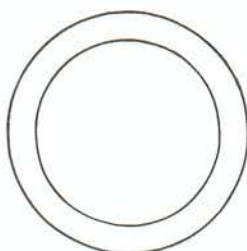

7525
F Z D

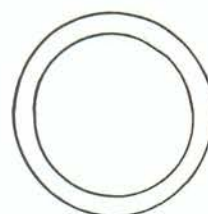

7579
F Z D

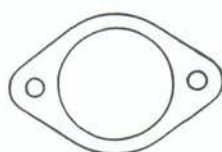

7493
28 FRGA

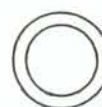

7489
FZD 24
FRD 28

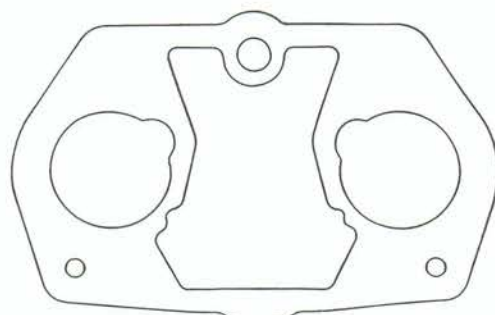

8117
36 DRLA
Alfa Romeo Alfa 33



ATTACCO CARBURATORE VETTURE ITALIANE



7041
Fiat N. 500



7078
Fiat N. 500 G.

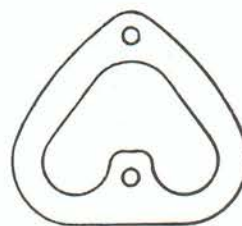

7518
Fiat 500 R - Fiat 126



7054
Fiat N. 500



7079
Fiat N. 500 G.



7590
Fiat 500 R - Fiat 126



7020
Fiat 1100 D



7215
Fiat 600 D - Fiat 850

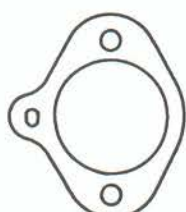

7124
Fiat 600 D - Fiat 850

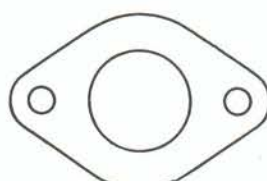

7406
Alfasud



7402
Fiat 127



7483
32 IBA
Fiat 127



7659
30 IBA



7371
Fiat 128



7712
34 ICEV
Fiat Ritmo



ATTACCO CARBURATORE VETTURE ITALIANE

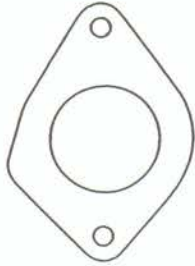

7972
Autob. Y 10 Fire
Fiat Uno Fire

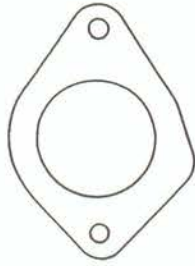

8052
Autob. Y 10 Fire
Fiat Uno Fire



7167
Alfa Romeo Giulia ϕ 40

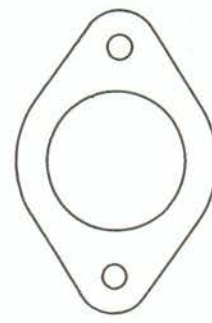

7276
Alfa Romeo Giulia



7273
40 DDH



7434
Alfa Romeo Giulia ϕ 45

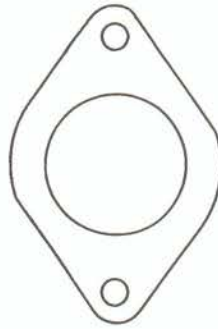

7403
40 IDF

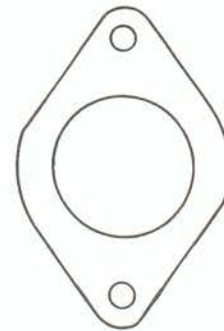

7523
42 IDF
Abarth Rally

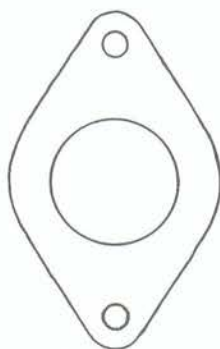

8091
Fiat Ritmo 105 TC



7834
Alfa Romeo Alfasud Sprint

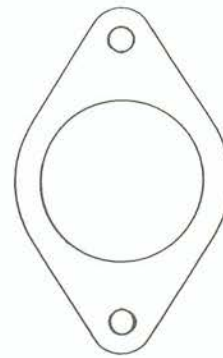

7971
Fiat Ritmo 130 TC - Abarth



ATTACCO CARBURATORE VEETURE ITALIANE

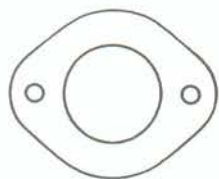

7745
Fiat 900 T.

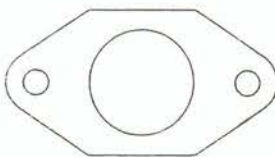

7277
Fiat 238

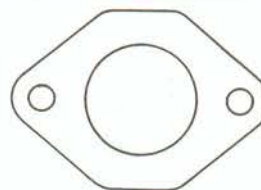

7926
Fiat 127 1050 cc.

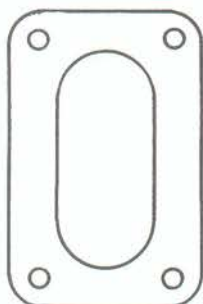

7181
Fiat 850 Coupé

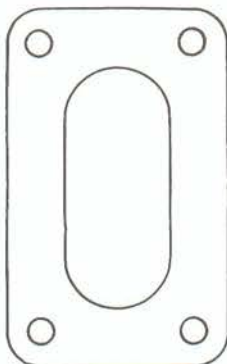

7425
Fiat 128 Rally

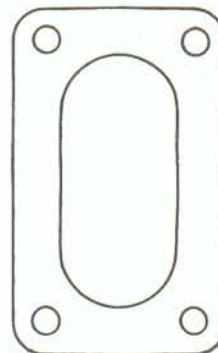

7524
34 DMTR
Lancia Beta

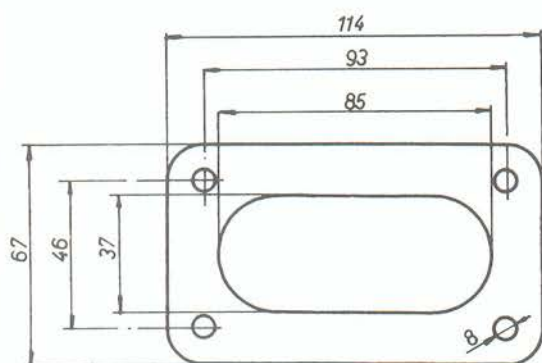

7281
Fiat 124 - 125

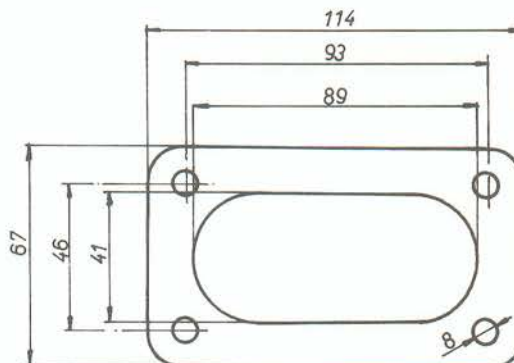

7301
Fiat 1300 C - 1500 C

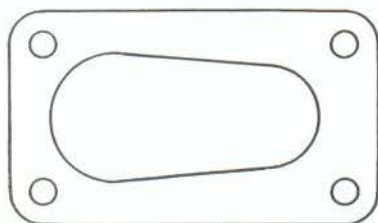

7066
Fiat 1300 - 1500

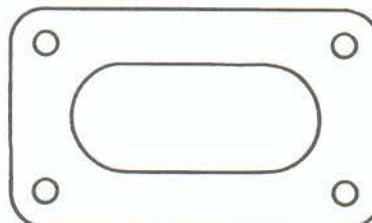

7346
Fiat 124 Special T



ATTACCO CARBURATORE VETTURE ITALIANE

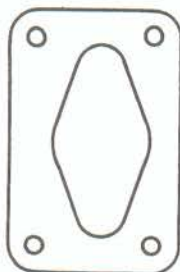

7153
Fiat 850

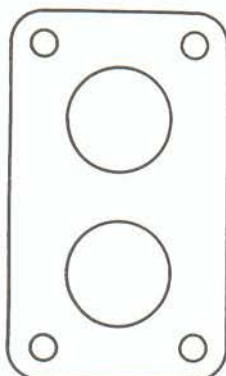

7031
Alfa Romeo Giulia

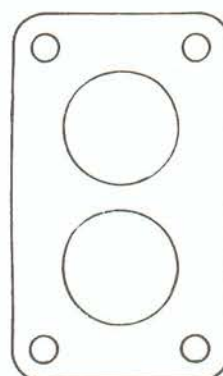

7588
Fiat 132

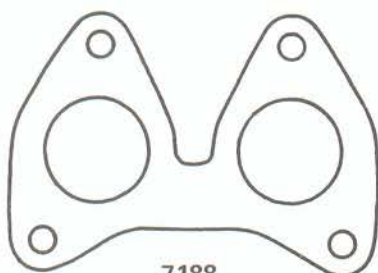

7188
Fulvia 2 C

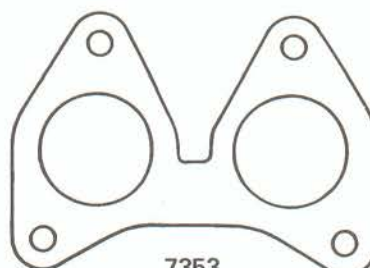

7353
Fulvia Rally

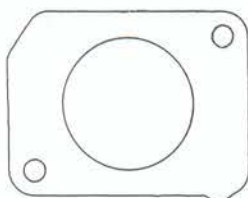

7974
Alfa Romeo Alfa 6

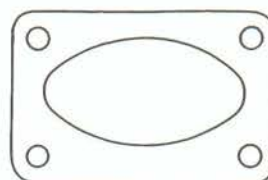

7747
Autobianchi A 112 Abarth



ATTACCO CARBURATORE VETTURE ITALIANE

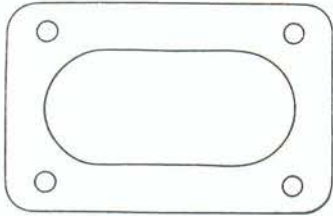

7997
Fiat Tipo 1^a Serie

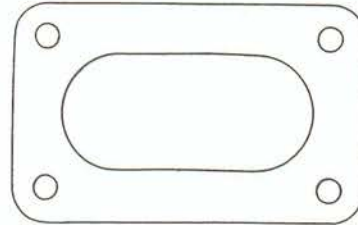

7998
Lancia Delta 1600 - Prisma 1600

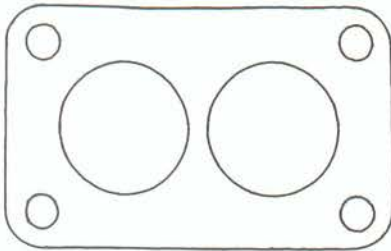

7977
Fiat Ritmo 75 Super

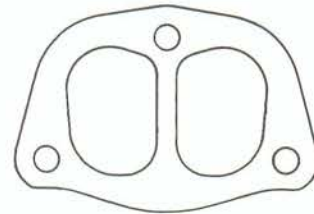

7800
Fiat Panda 30 (attacco collettore)

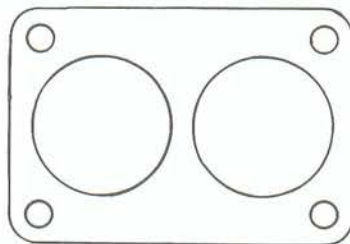

7437
40 DCNF



SUPPORTO COPERCHIO FILTRO ARIA TIPI ITALIANI ED ESTERI



7048
Fiat N. 500

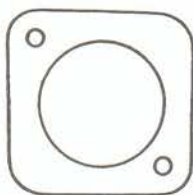

7519
Fiat 500 R - 126

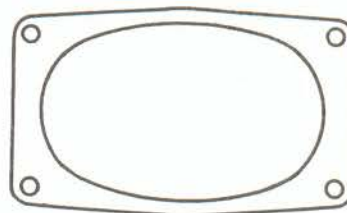

7074
32/34 PAIA

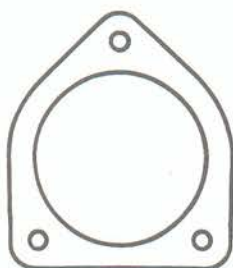

7347
32 OF

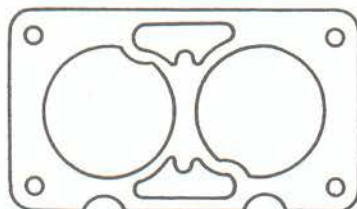

7027
36 DCD

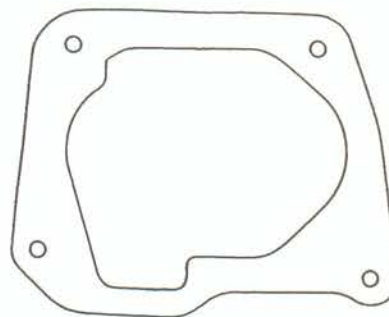

7650
34 DMTR

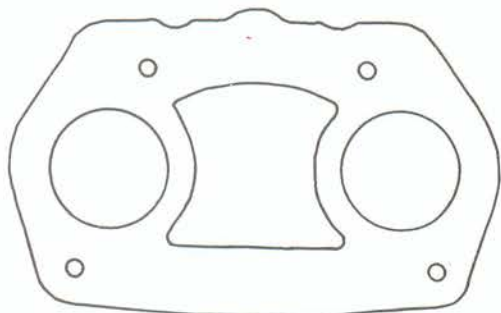

7411
40 IDF

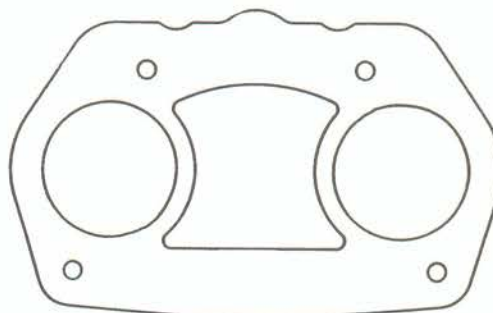

7587
Abarth 124 Rally



7186
Alfa Romeo Giulia

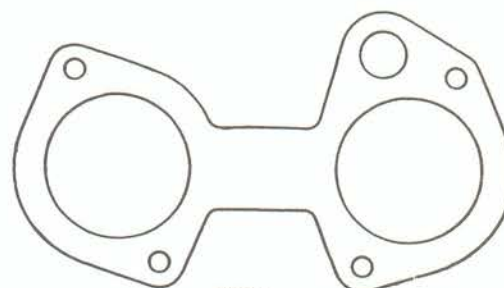

7511
Fulvia HF 1600



SUPPORTO COPERCHIO FILTRO ARIA TIPI ITALIANI ED ESTERI

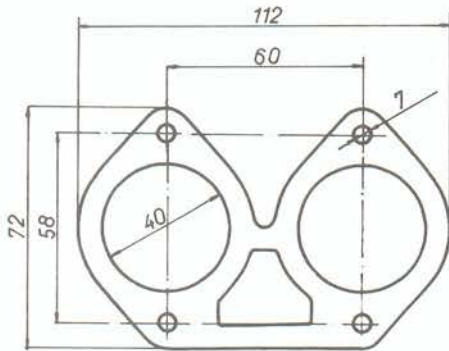

7231
Fulvia 2 C

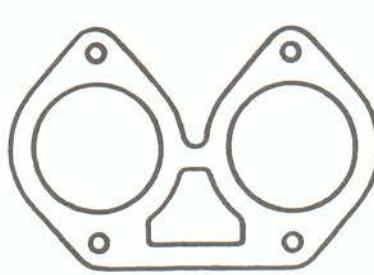

7366
Fulvia Rally

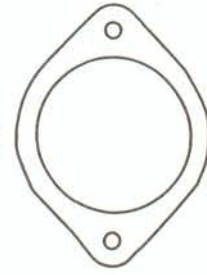

7690
40 TIN - Zenith

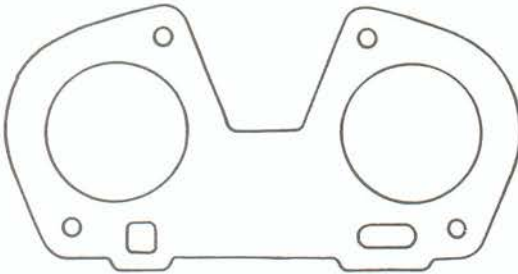

7535
VW K 70

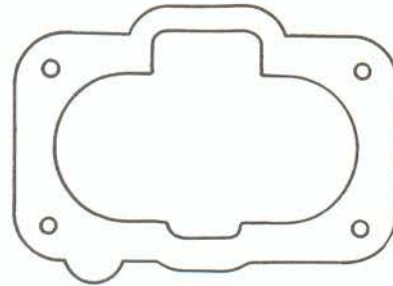

7578
40 DCNF

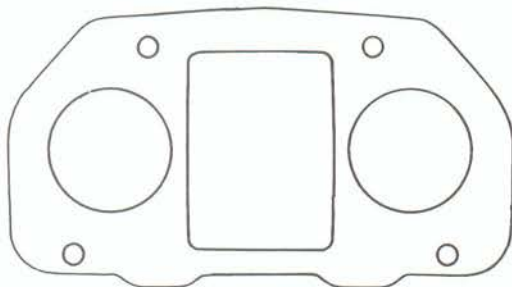

7436
40 PII
Fiat 124

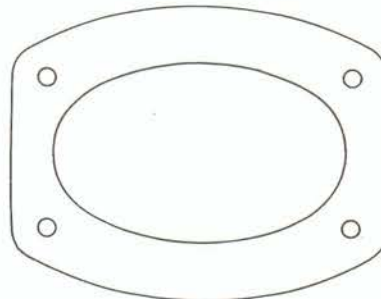

7721
Simca 1307 - 1308

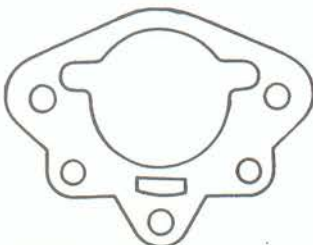

7571
Volvo - BMW 2000

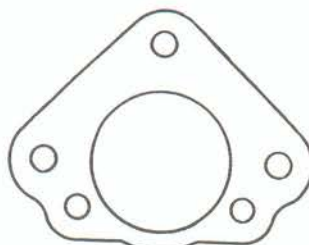

7572
Volvo 142 - 144 - 145

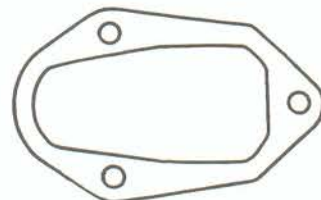

7527
RO 80



SUPPORTO COPERCHIO FILTRO ARIA TIPI ITALIANI ED ESTERI



7581
40 DCNF

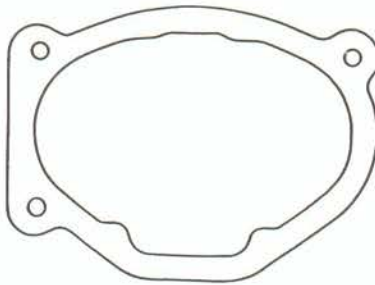

7657
Simca 1100 TI

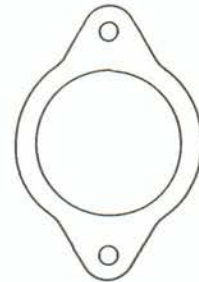

7746
Fiat 900 T

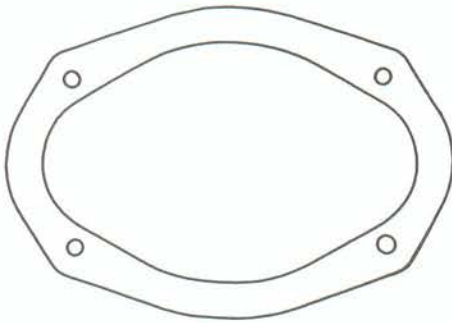

7612
Renault R15 - R17

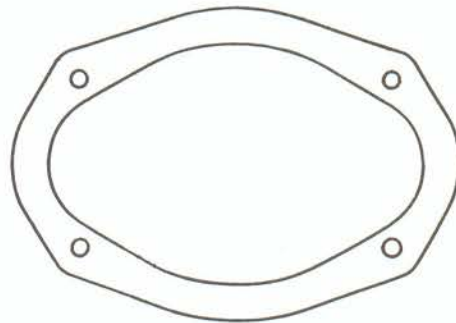

7565
38 ADS
Chrysler 160 GT - 180

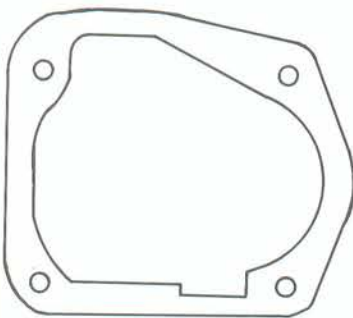

7864
Lancia Prisma

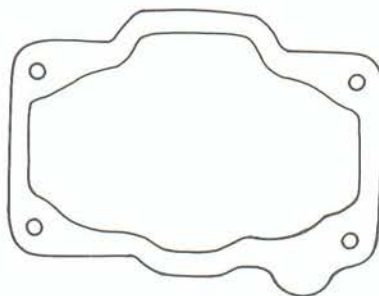

7922
Lancia Delta 1500 cc.



7798
Fiat 238



SUPPORTO COPERCHIO FILTRO ARIA TIPI ITALIANI ED ESTERI

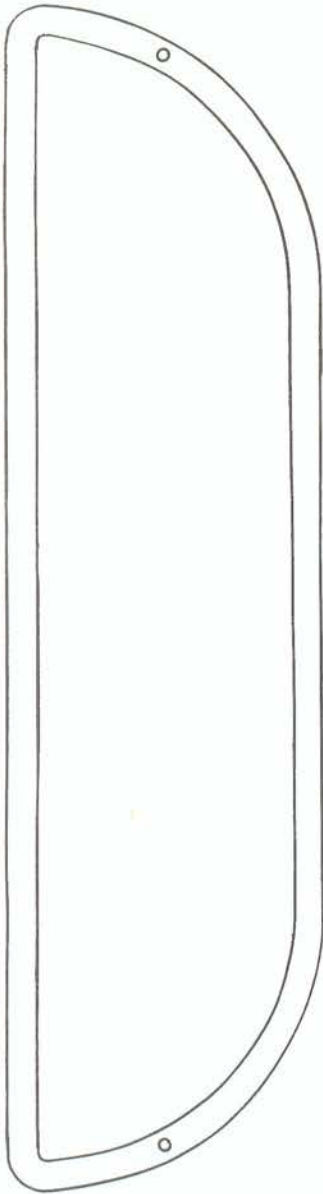

7585
Alfa Romeo Giulia

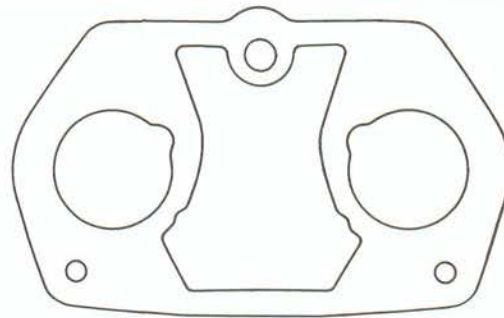

7796
36 IDF
Alfasud Sprint 1300 - 1600

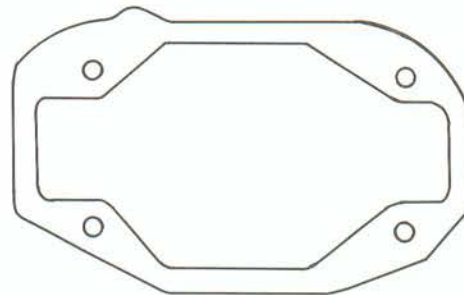

7883
36 DCNAV
Lancia Volumex

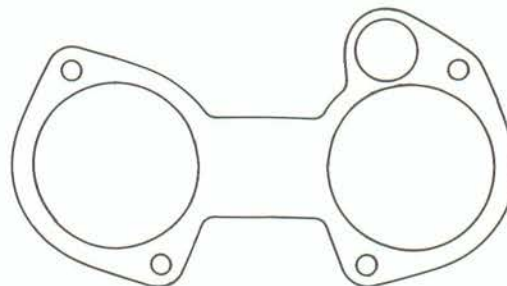

7915
Fiat Ritmo 130 TC Abarth



7809
Mini Minor S.U.



ATTACCO POMPE BENZINA TIPI ITALIANI ED ESTERI

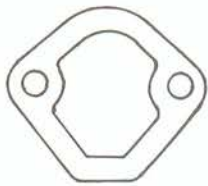

7163
Fiat 1300 - 1500



7163 BIS
Fiat N. 500 F - 600 D
Fiat 850 - 124



7391
Fiat 128

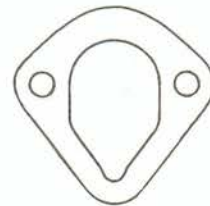

7382
Fiat 128



7557
Fiat 132 - Lancia Beta

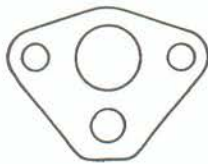

7510
Alfasud



7509
Alfasud

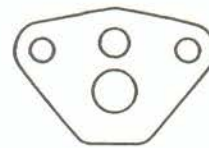

7508
Fulvia



7206
Fiat 1100 R - 124

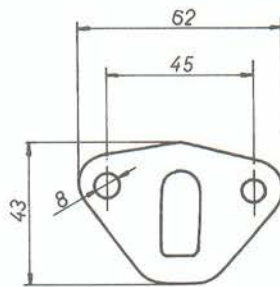

7313
Simca 1000 - 1300 - 1500



7574
Alfetta

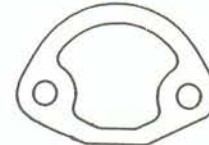

7459
VW 1200 - 1300

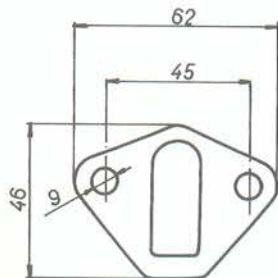

7244
Alfa Romeo Giulia

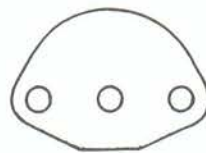

7458
VW 1200 - 1300



7335
Opel



ATTACCO POMPE BENZINA TIPI ITALIANI ED ESTERI



7616
Renault - Ford - Opel

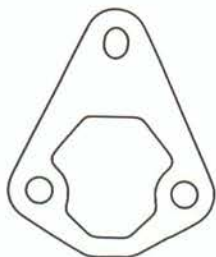

7618
Renault R15 - R16



7640
Citroën DS. 19-21-23

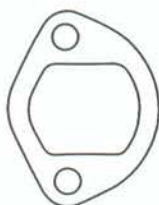

7643
BMW
tutti i tipi

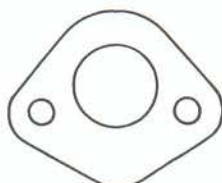

7644
Audi
tutti i tipi

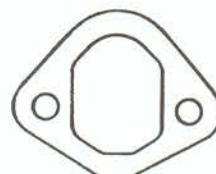

7617
Opel Kadett C.
1000 - 2000



7848
Fiat 127 1050 cc.

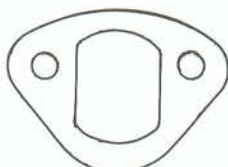

7913
Mini 120



7640
Citroën DS



7648
Mini Regent tutti i tipi



COPERCHIO CARBURATORE VETTURE FRANCESI

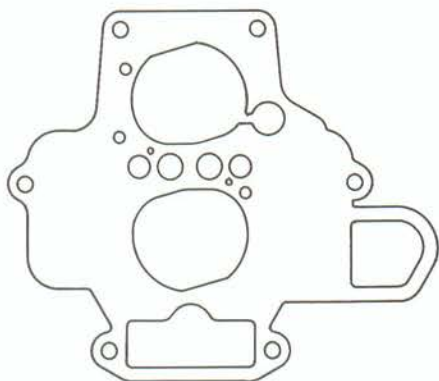

7866
32 DRTM/0
Renault R9 GTS

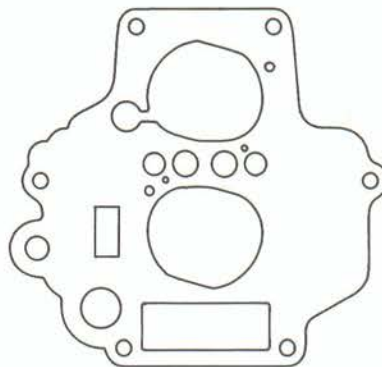

7868
32/34 DMTC 100
Citroën Visa Eco

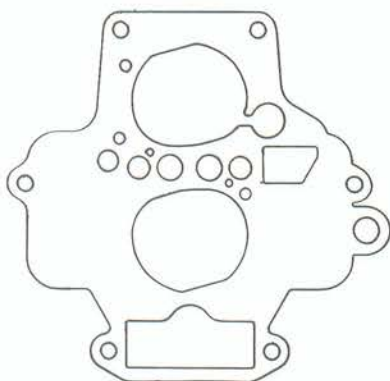

7871
32/34 DRTC 2/100
Citroën BX 16 RS/TRS 1600 cc.

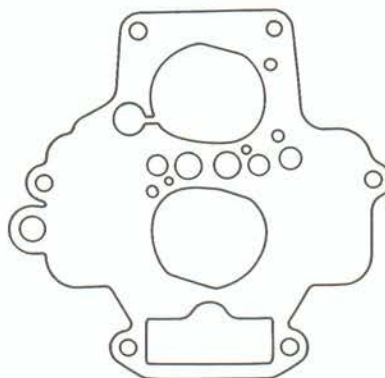

7904
32/34 DRTC
Citroën BX 16

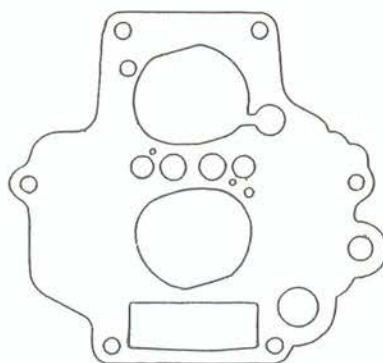

7979
34 DATC
Renault R9 - R11



COPERCHIO CARBURATORE VETTURE FRANCESI

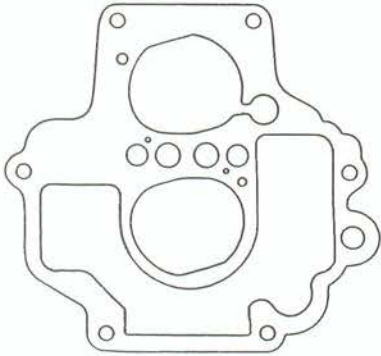

7987
30/32 DMTE
Citroën BX 19 - Peugeot 305 - 309

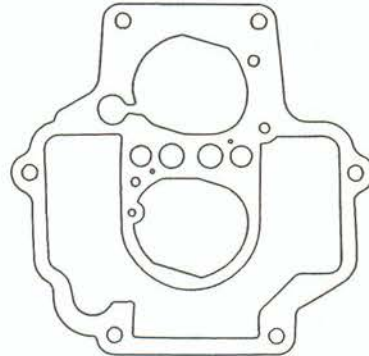

8090
34 DRTC
Citroën BX 19 - Peugeot 305 - 309

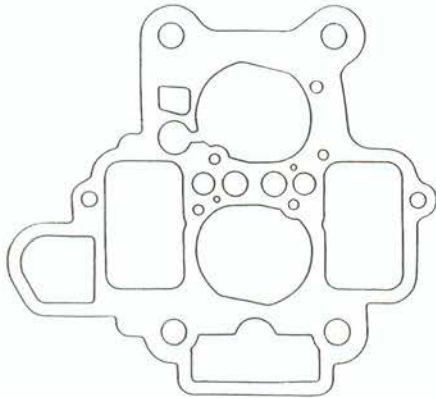

7970
32 DRT
Renault R9 - R11

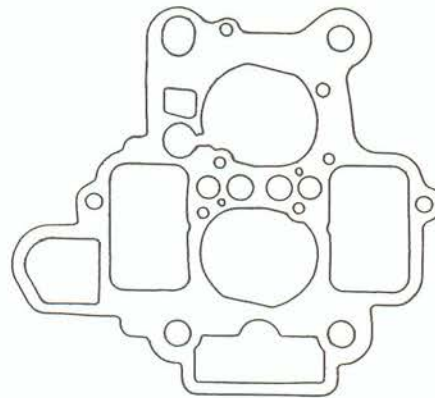

8102
32 DRT
Renault R9 - R11

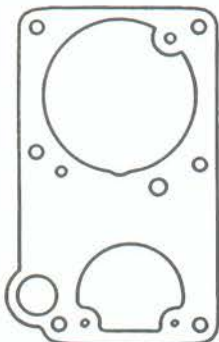

7194
30 PICS

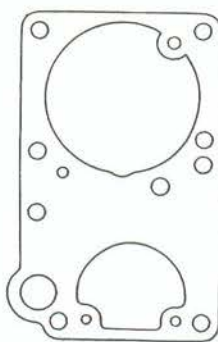

7564
34 PICS

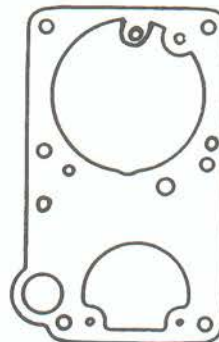

7592
34 PICS

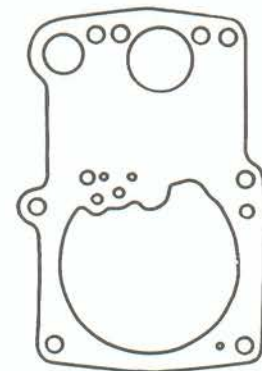

7197
40 PICS



COPERCHIO CARBURATORE VETTURE FRANCESI

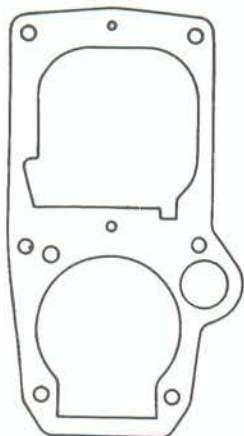

7451
Renault R16

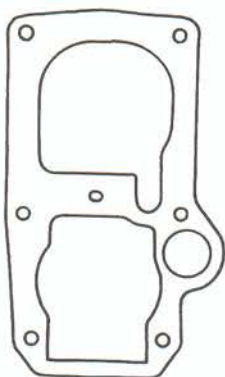

7577
Renault R6 - 1100

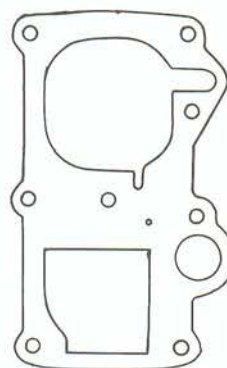

7835
32 IF 2
Renault R9 - Supercinque

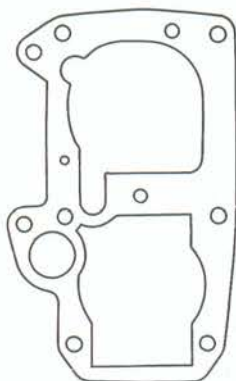

7859
32 IF
Renault R5 GTL - R9

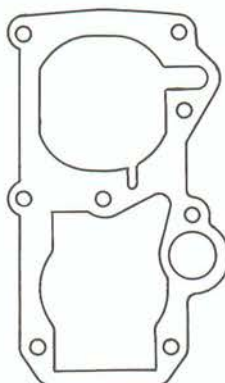

7860
32 IF 2
Renault R5 GTL

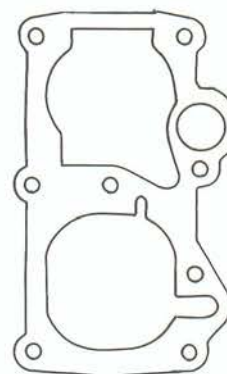

7910
32 IF
Renault R9 - R11

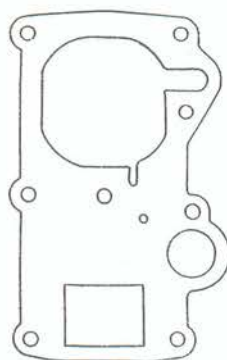

7975
32 IF
Renault R9 - R11

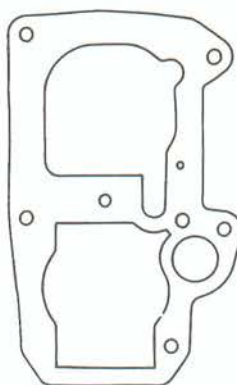

7695
Zenith IF
Renault R12 TL

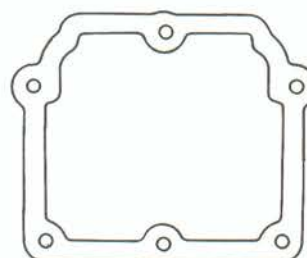

7858
Stromberg
Talbot Sunbeam



COPERCHIO CARBURATORE VETTURE FRANCESI

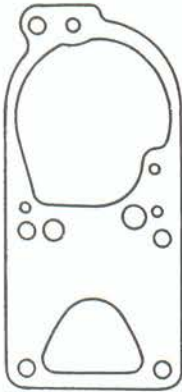

7139
32 PDIST

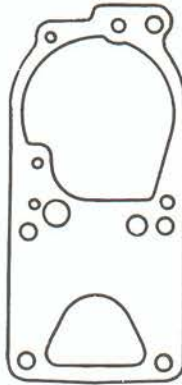

7196
32 PDST

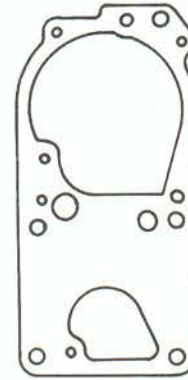

7242
32 DISTA

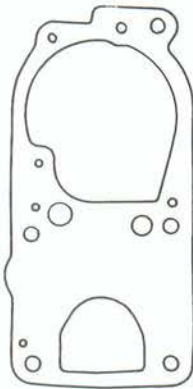

7697
32 DIS

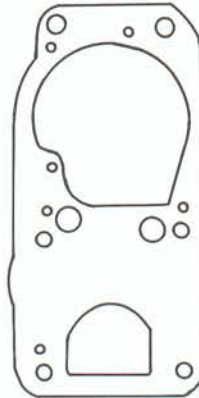

7896
32 DIS
Renault R18 Turbo

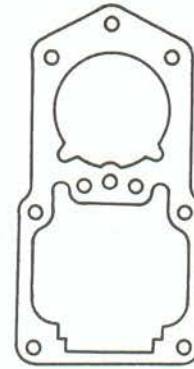

7131
28 IF



7422
32 EISA-3

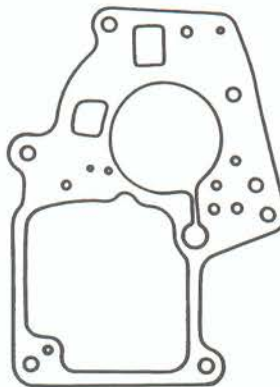

7614
32 SEIA

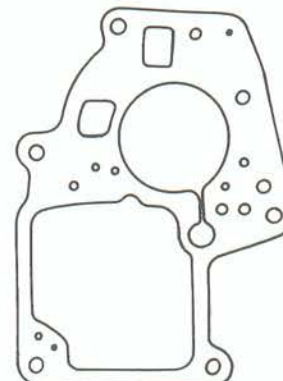

7699
32 SEIA



COPERCHIO CARBURATORE VETTURE FRANCESI

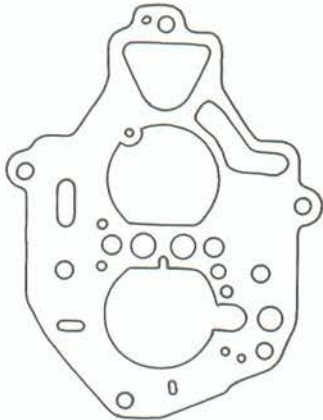

7929
30/30 Z2
Citroën BX

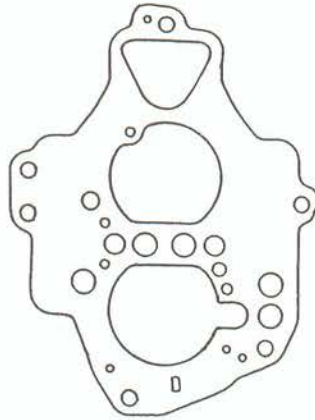

8074
28/34 Z9 - 28/34 Z10
Citroën BX 14E - 14RE 1360 cc. 5 VIT
Renault R21 - R9 - Volvo 360

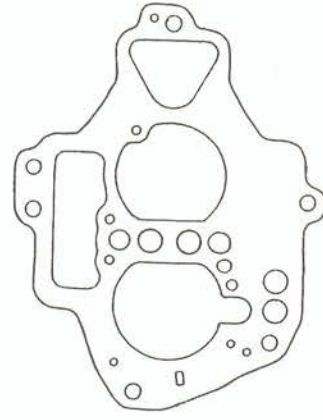

8111
28/34 Z10
Renault R21

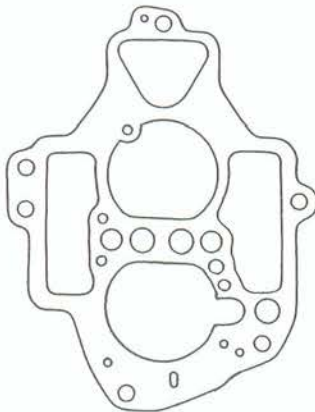

8092
28/34 Z9 - Z10
Renault R9 - R11 - R21

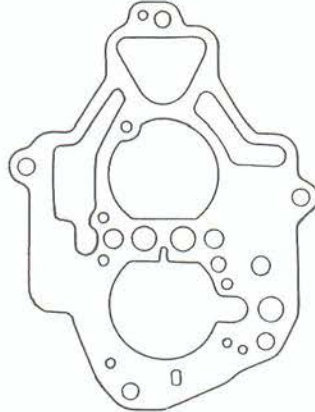

8136
28/34 Z10
Renault R19

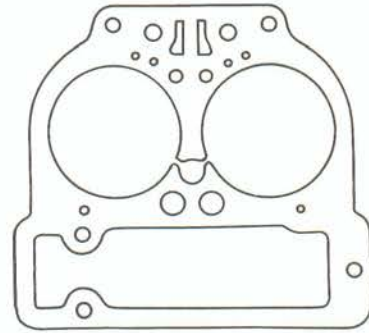

7660
40 DCNF

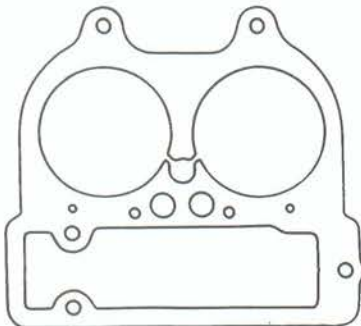

7661
DCNV/100

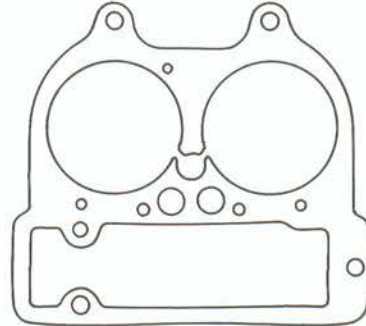

7884
40/42 DCNF
Simca-Talbot



COPERCHIO CARBURATORE VETTURE FRANCESI



7104
32 PBICA

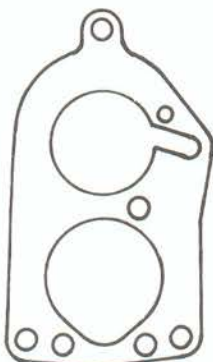

7323
32 BICSA



7324
34 PBICA

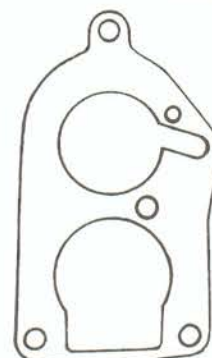

7609
32 BICSA

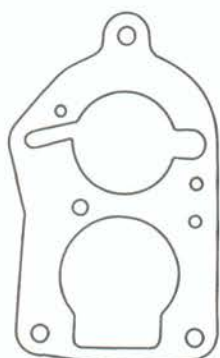

7663
32 BICSA

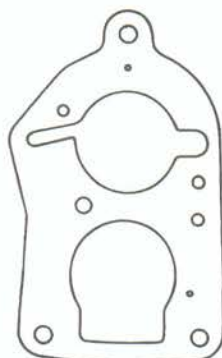

7744
32 BICSA-7A

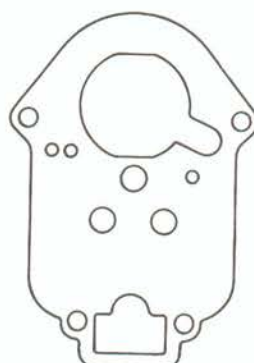

7213
32 ICB

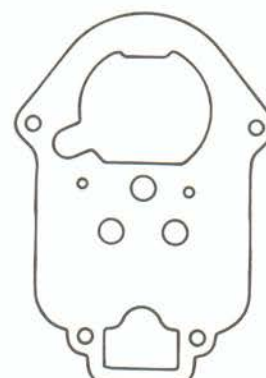

7448
34 ICR-8

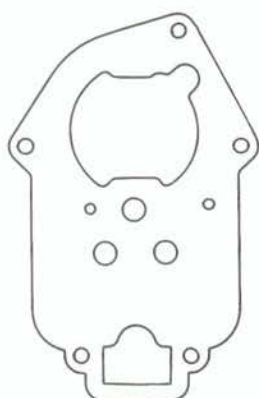

7674
32 IBS

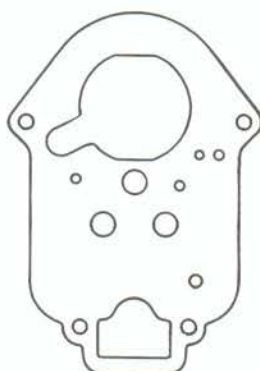

7742
32 ICT 250

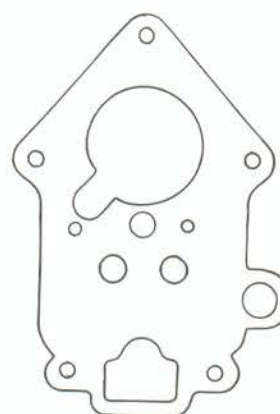

7912
32 IRE
Renault R5



COPERCHIO CARBURATORE VETTURE FRANCESI

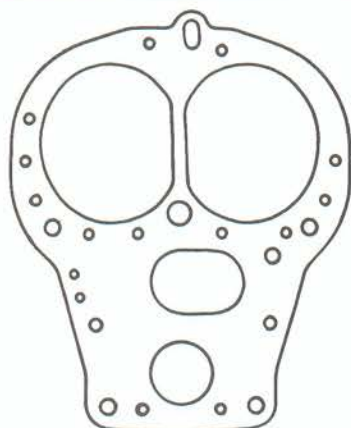

7367
35 SDID

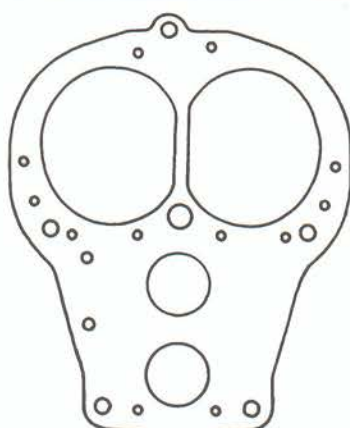

7325
32 SDID-2



7710
32 TMMIA

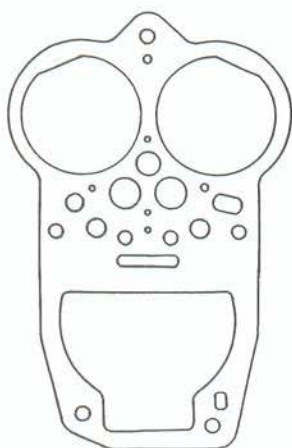

8085
32/35 TMIMA
Talbot Tagora GL - GLS
Peugeot 504 Eur. mot. XN 1 Break
Peugeot 505

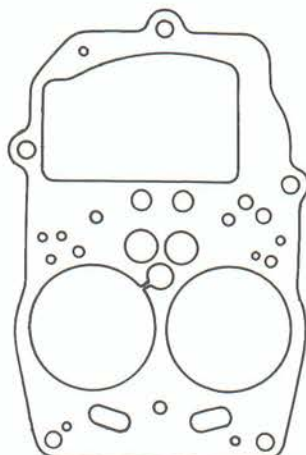

7825
32 SEIA
Peugeot 504
Renault R20

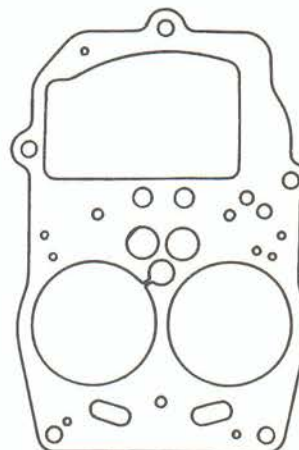

7545
Peugeot 504

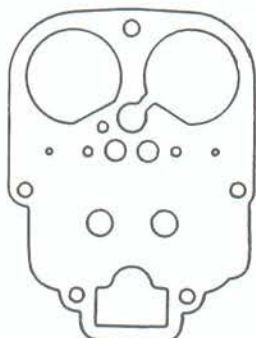

7517
Citroën GS 1000 - 1200

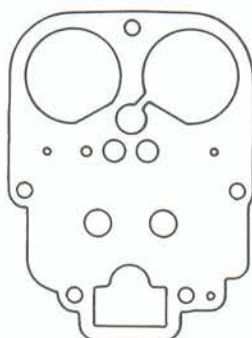

7826
30 DGS 17/250
Citroën GS

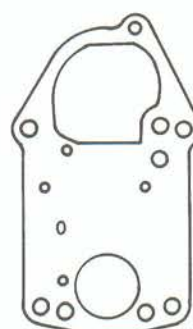

7259
26 DIS



COPERCHIO CARBURATORE VETTURE FRANCESI

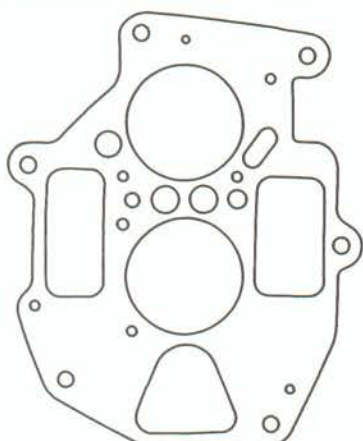

7704
32/35 TCICA

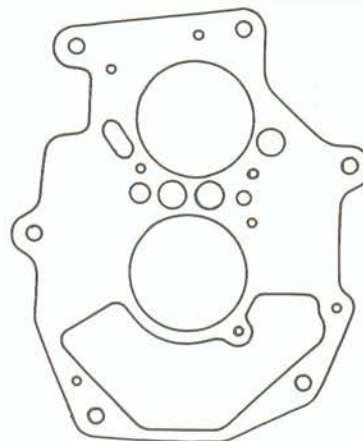

7819
32/35 C1CSA
Renault R14 TS



7593
28/36 DMD



7185
28/36 DDC

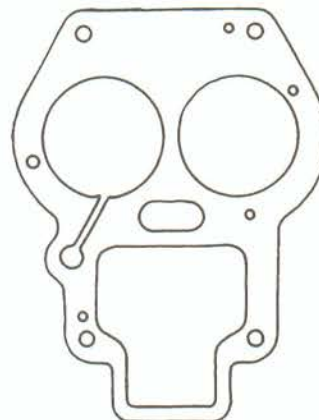

7468
28/36 SFIF



7803
32 DIR
Renault R5 1400

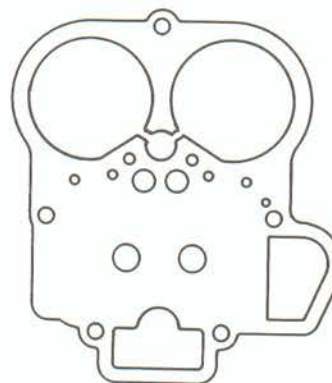

7801
32 DIR - 32 DARA
Renault R5 - R18



COPERCHIO CARBURATORE VETTURE FRANCESI

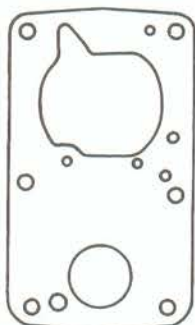

7260
32 PBISA - 2

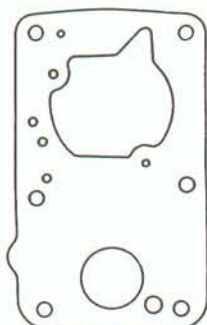

7675
34 PBISA

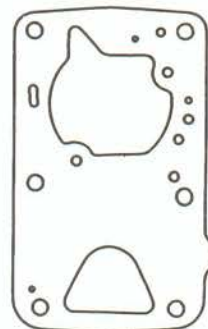

7716
34 PBIS

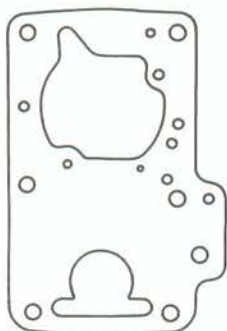

7740
34 TBIA

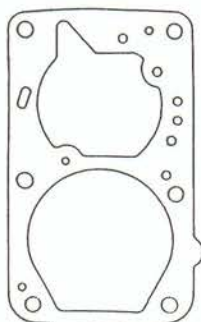

7993
32 BIS - 34 PBISA
Renault Supercinque
R 9 - Peugeot 104

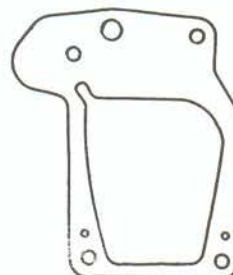

7568
DAF 66

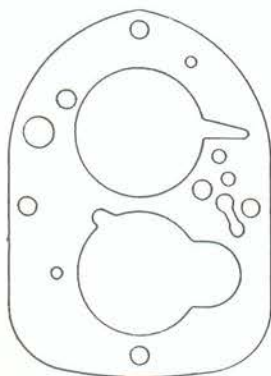

8088
40 RAIP
Renault RVI Saviem

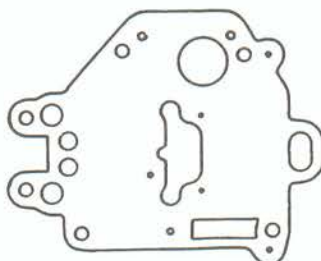

7554
35 PHHE

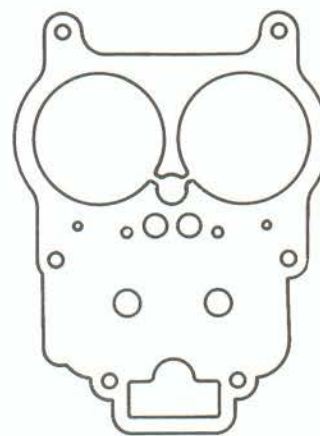

7446
38 ADS



COPERCHIO CARBURATORE VETTURE FRANCESI

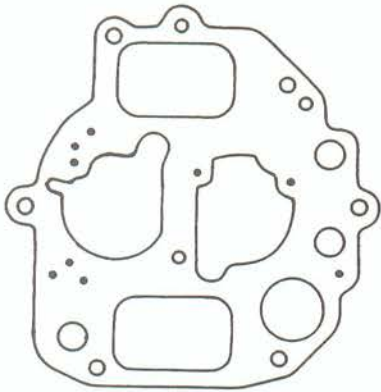

7450
Ami 6 - Ami 8

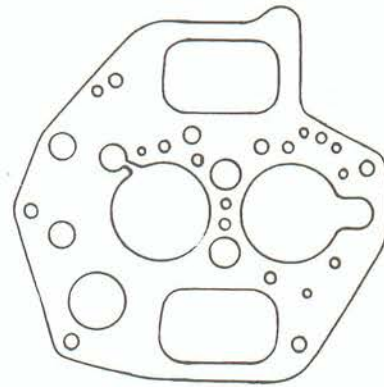

7486
Ami 8 GS

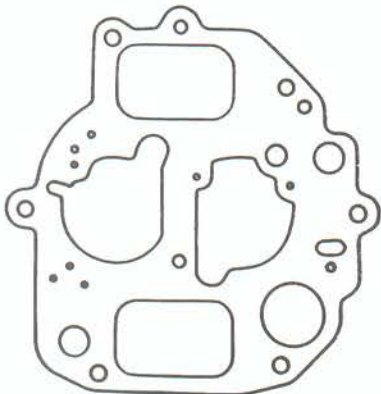

7604
Dyane 6

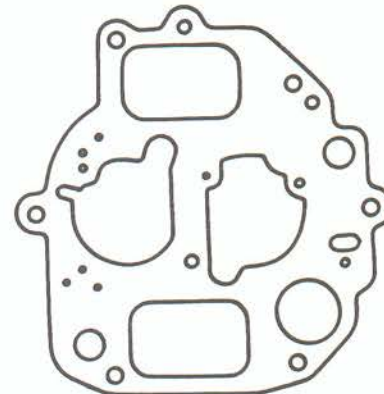

7604 u.t.
Dyane 6

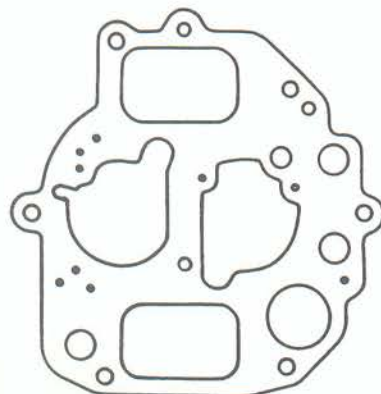

7620
Ami 6 - Dyane 6

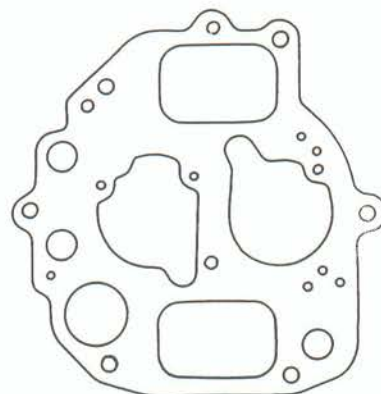

7696
Citroën



COPERCHIO CARBURATORE VETTURE FRANCESI

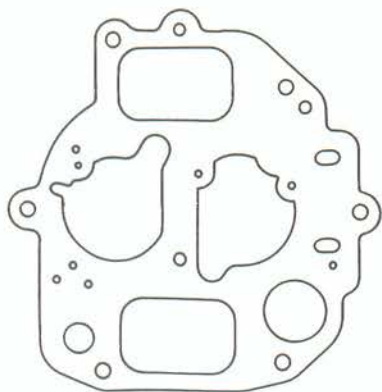

7700
Dyane

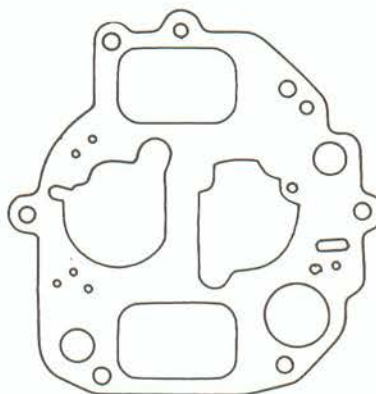

7795
26/32 CSIC

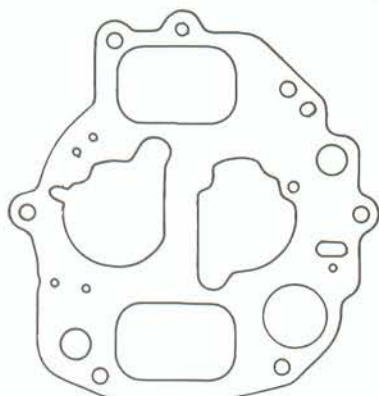

7795 bis
26/35 CSIC

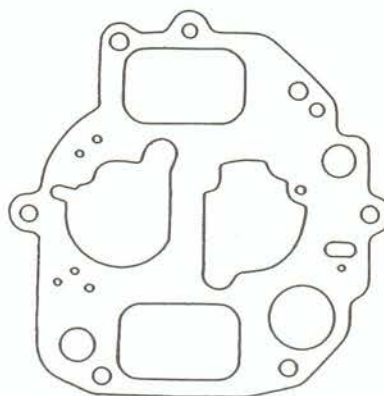

7933
26/35 SCIC

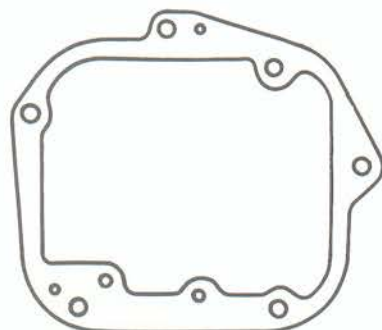

7608
Peugeot 104

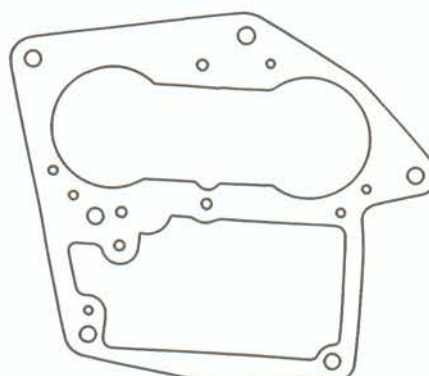

7736
35 CEEI



INTERMEDIE VETTURE FRANCESI

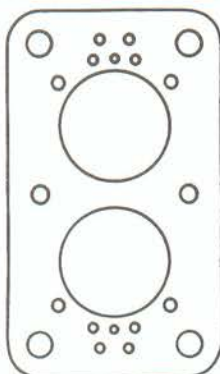

7369
35 SDID

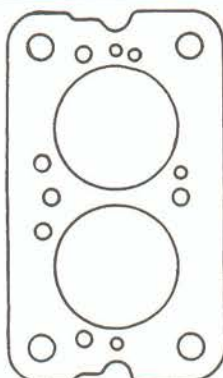

7480
Chrysler 160 GT

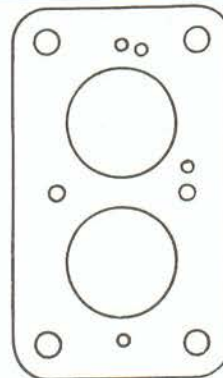

7506
Chrysler 160

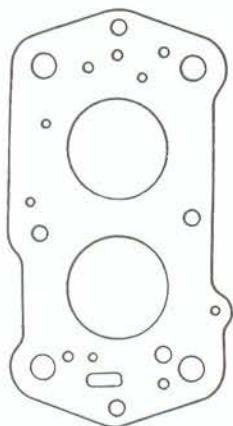

7546
Peugeot 504

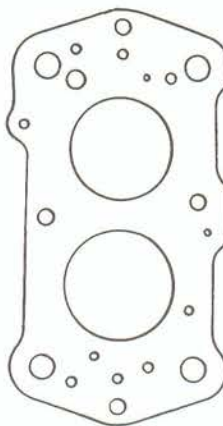

7547
Peugeot 504

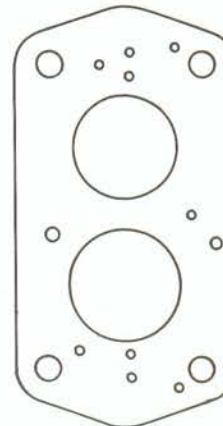

7845
Peugeot 304 S

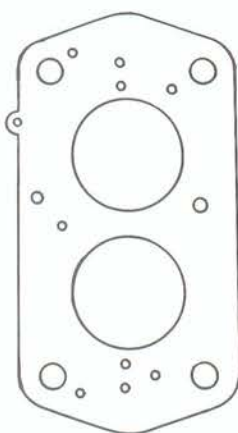

7882
32 EEISA
Peugeot 304 S

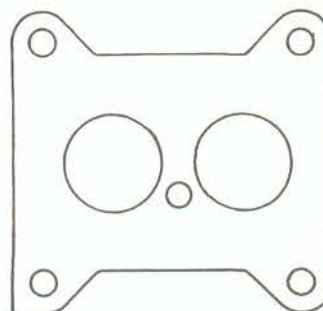

7589
Citroën GS 1000 - 1200



INTERMEDIE VETTURE FRANCESI

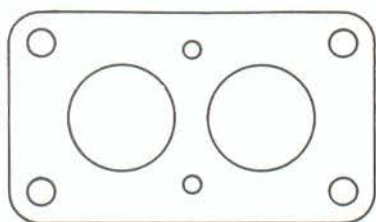

7601
R 15 - R 17

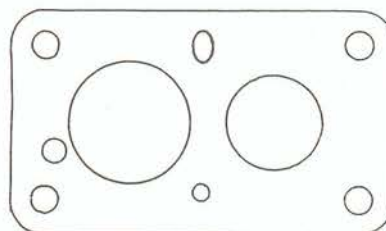

7969
28/36 DARA
Renault R 25

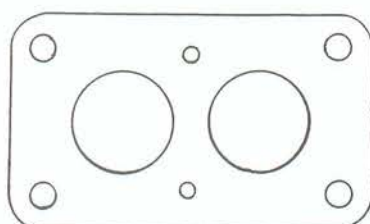

8009
32 DRT
Renault R 9 - R 11

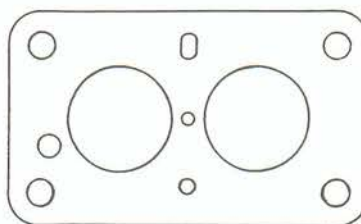

8059
32 DIR
Renault R 9 - R 11

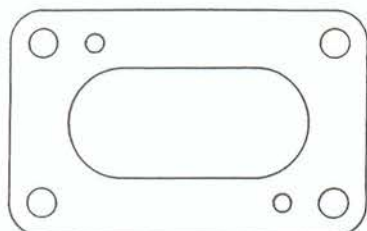

8080
32 DRT
Citroën BX 14E - RE 1360 cc. 5 Vit
Renault R 9 - R 11 - R 21 - Volvo 360

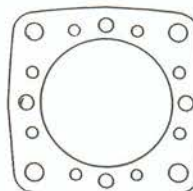

8084
40 RAIP
Renault RVI Saviem

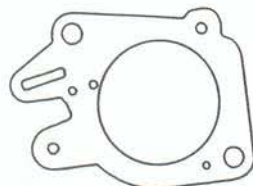

8070
36 TLP
Peugeot 309

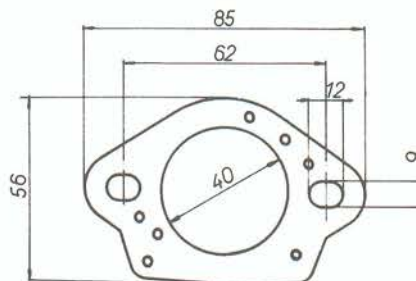

7255
35 DISA



INTERMEDIE VETTURE FRANCESI

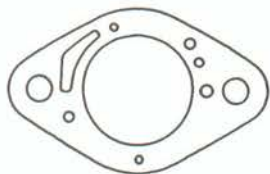

7741
34 PBISA-5

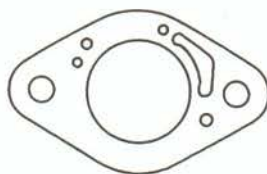

7734
32 BISA

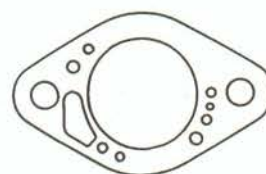

7739
34 TBIA

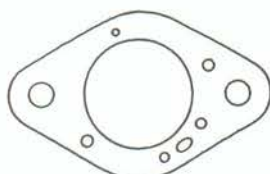

7669
35 BISA

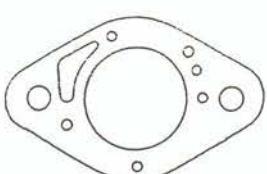

8054
32 PBISA

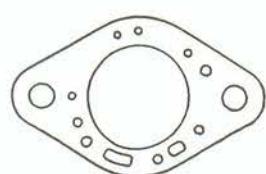

8087
32 PBISA - 32 PBISA 12

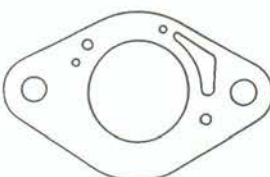

8058
32 BIS
Renault R 9 - R 11

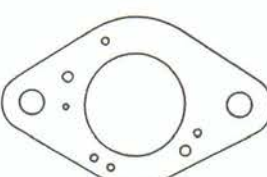

8050
32 BIS
Renault R 9 1100 cc.

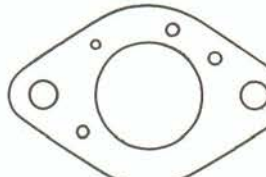

7905
32 IF 2
Renault R 9 TL - GTL

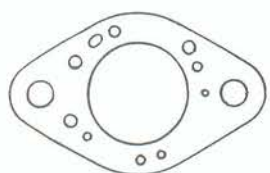

8055
32 PBISA
Peugeot 204

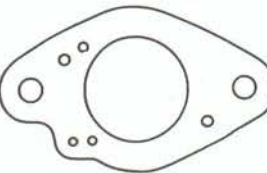

7729
32 DIS 15

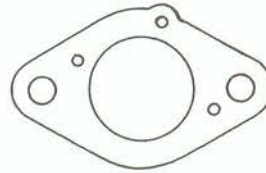

7799
32 IBP
Peugeot 104 SL - GL 1124 cc.

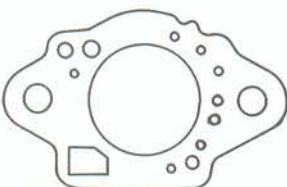

7914
34 EISA-EITA - 35 EITA
Renault R 5 - R 18 - R 18 Turbo

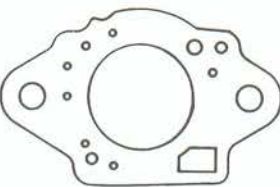

7444
32 EISA 3

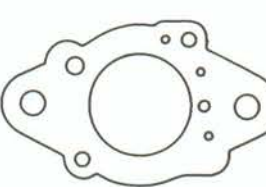

7861
32 IF
Renault R5 GTL - R 6 - R 12



INTERMEDIE VETTURE FRANCESI

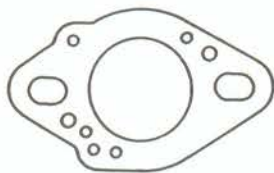

7141
32 PDIST

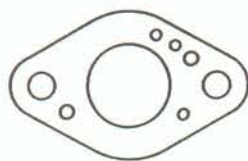

7144
26 DIS

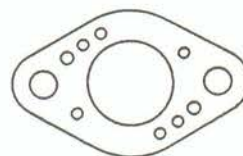

7957
26 DITS - DIS
Renault R 4

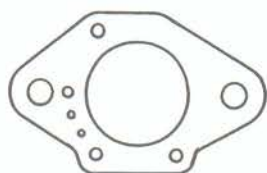

7569
Daf 66



7570
R 6 1100

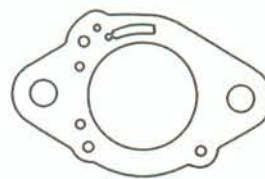

7730
35 PDSIT

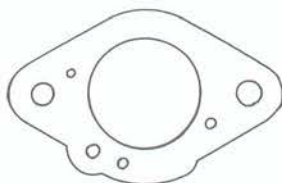

7967
34 IBP 1/100-1
Peugeot 305 GL - GR 1290 cc.

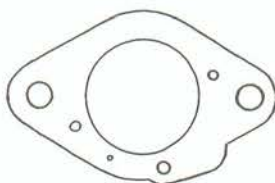

7968
35 IBSH 20/100 - 21/100
Talbot Samba 30 CV - 1360 cc.
Citroën Visa GT 1360 cc.
Peugeot 205 GT 1360 cc.
Talbot Samba 80 CV

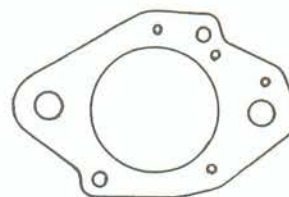

7502
Renault R 16

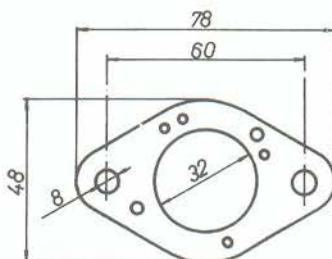

7254
32 PBISA



ATTACCO CARBURATORE VETTURE FRANCESI

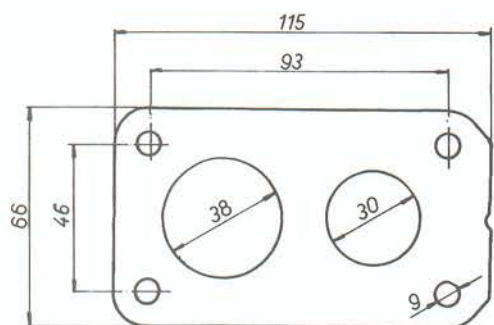

7278
Simca 1300 - 1500

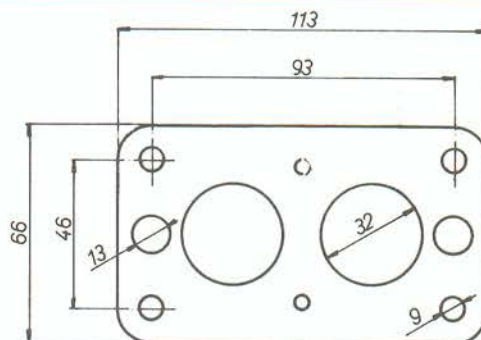

7317
32 DIR

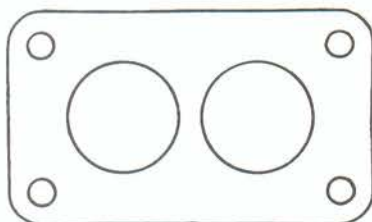

7368
35 SDID

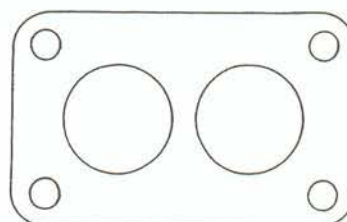

7996
34 DMTR
Citroën CX 2000

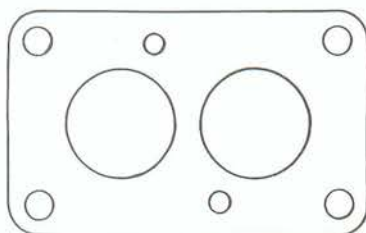

7899
32 DRTM/0
Renault R 9 GTS

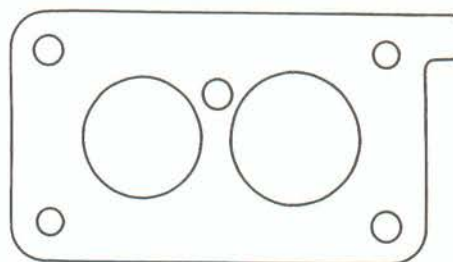

7992
TMIMA
Peugeot

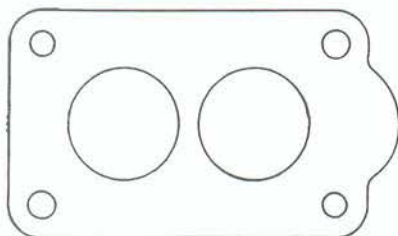

8089
28/34 Z 9 - 28/34 Z 10
Citroën BX 14E - 14RE 1360 cc. 5 Vit
Renault R 9 - R 21 - Volvo 360

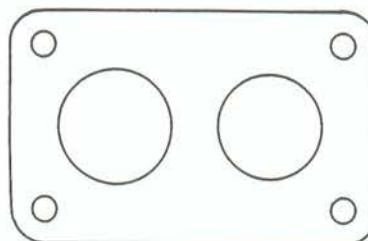

7820
32/35 CICSA
Renault R 14 TS



ATTACCO CARBURATORE VETTURE FRANCESI

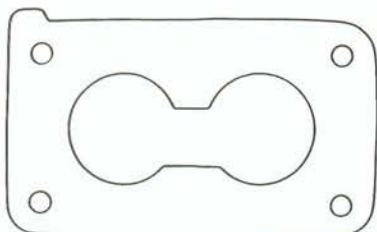

7711
32 TMMIA

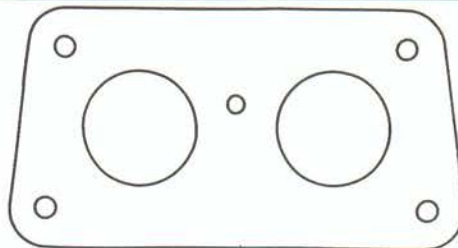

7735
35 CEEI

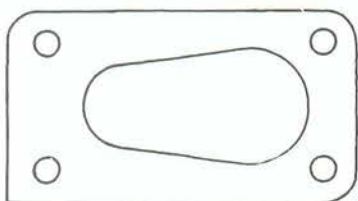

7449
Ami 6 - Ami 8

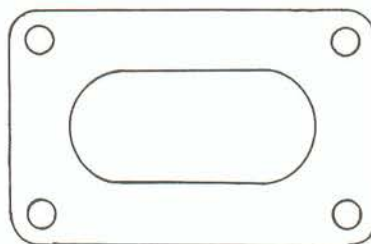

7966
32 DRT
Renault R 9 - R 11

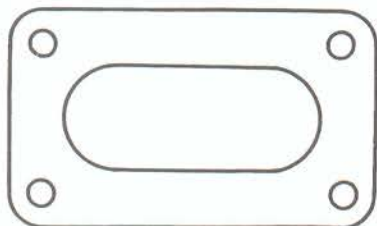

7881
35 EEISA
Peugeot 304 S

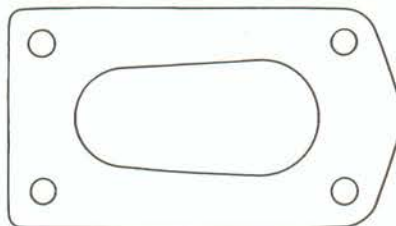

7808
32/35 SEIEA
Peugeot 504

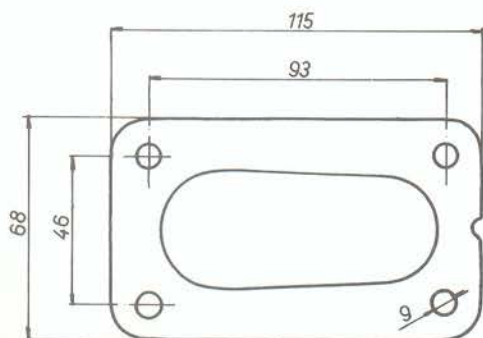

7279
Simca 1300 - 1500

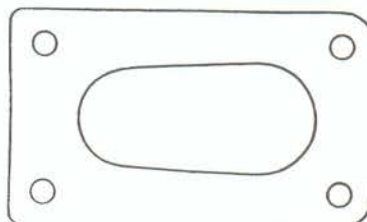

7540
Peugeot 504



ATTACCO CARBURATORE VETTURE FRANCESI

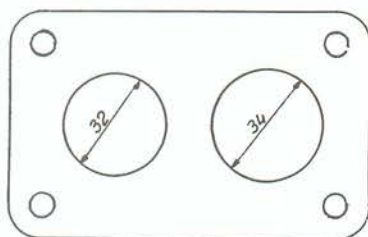

8060
32/35 TCICA
Citroën BX 14 E

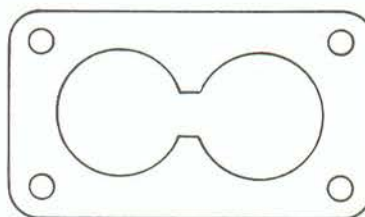

7529
Chrysler 160 GT

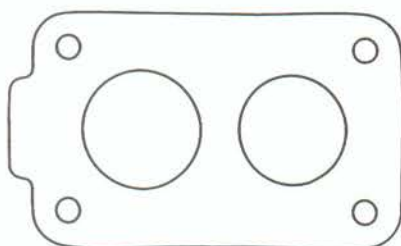

7706
32/35 TCICA

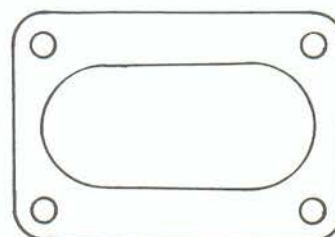

7530
Simca 1300 Special

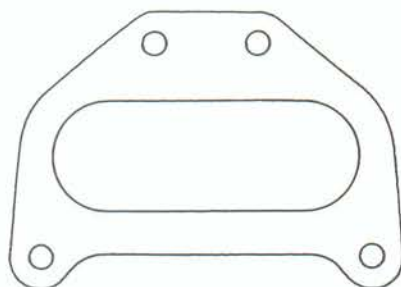

7748
35 PHHE

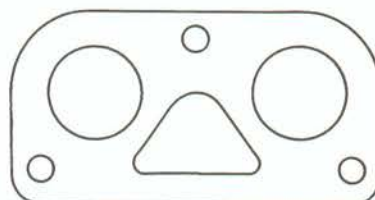

7639
Citroën GS 1000 - 2000

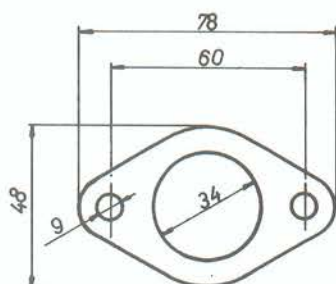

7268
32 PBISA

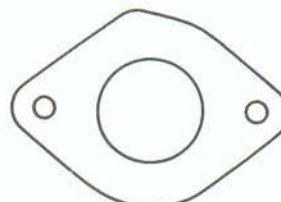

7693
Renault



ATTACCO CARBURATORE VETTURE FRANCESI

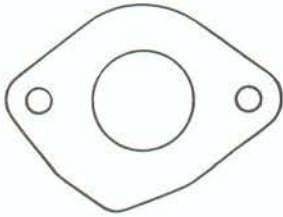

7607
Peugeot 104

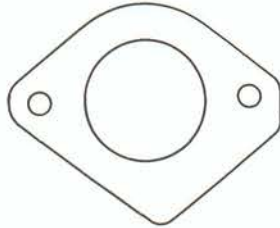

7806
32 HSA
Peugeot 104
Renault R 14

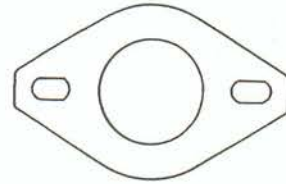

8051
32 DIS - 32 BIS
Renault R5 Turbo - R18 Turbo
R5 GT Turbo - R9 1100 cc.

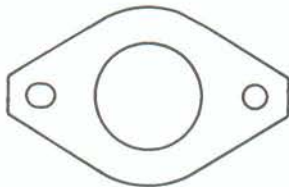

7445
Renault R 12 - R 16

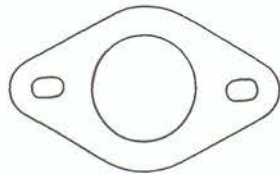

8066
35 SEIA
Renault R 18 Fuego
Renault Master

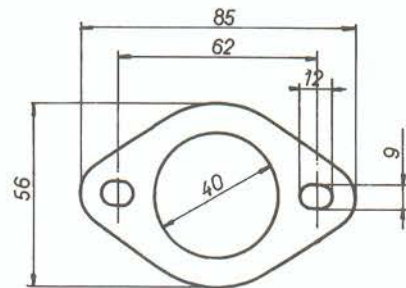

7272
35 DISA

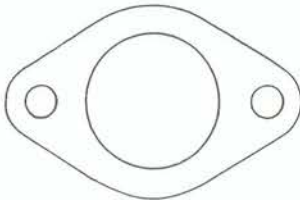

8082
40 RAIP
Renault RVI Savier

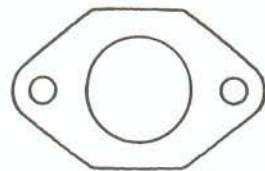

7567
Daf 55/66

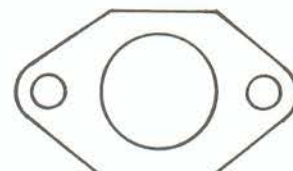

7591
Renault R 16 TL

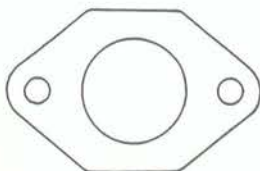

7846
Peugeot 104 GR

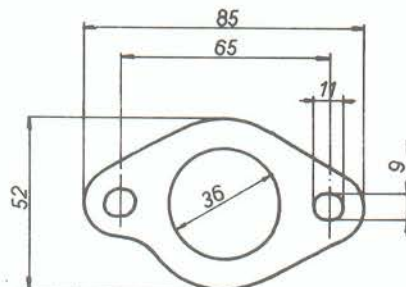

7270
Simca 1500



7738
34 TBIA



ATTACCO CARBURATORE VETTURE FRANCESI

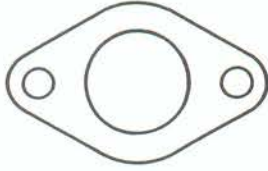

7102
30 PSEI

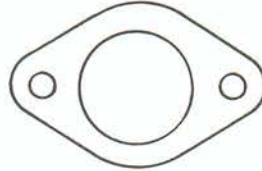

7580
34 ICR

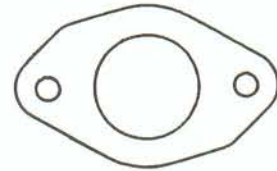

7466
Renault R 8 - R 10

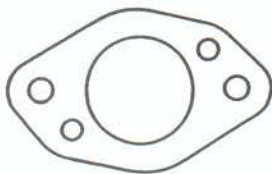

7140
32 PDIST

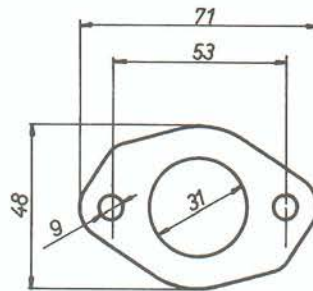

7282
32 PDIST

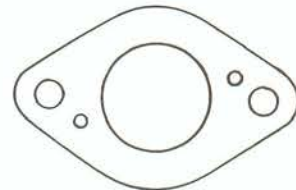

7921
32 IRE
Seat Fura



INTERNE VETTURE FRANCESI

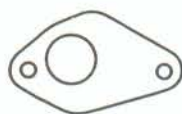

7692
Renault R 16

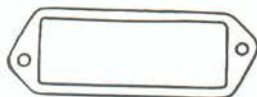

7635
35 CEEI

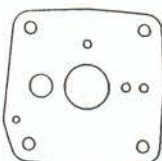

8083
40 RAIP
Renault RVI Saviem



8000
32/35 TMIMA
Talbot - Peugeot



7707
32 TMMIA
32/35 TCICA



7709
32/35 TCICA
Peugeot 104 - 205 - 304 S



7548
35 PHHE



7872
32/34 DRTC 3/100
Citroën BX 1600 RS-TRS



8086
32 PBISA
Peugeot - Talbot - Citroën



7827
32 SEIA
Renault R18 - R12 - R6



7732
Renault R5 TL - R6 - R12



8075
32 IF
Renault R9



7828
32 SEIA - SEIMA
Renault R4 - R5 - R6 - R12



7733
32 SEIA



7705
32/35 TCICA
Peugeot 304 S

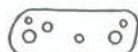

7991
32 DIS
Renault R18 Turbo
R5 Turbo - R5 GT Turbo



7963
32/35 CICSA
Renault R14 TS

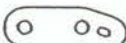

7964
32/35 CICSA
Renault R14 TS



7950
32 DIR
Renault R5 - R5 TS - R12

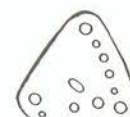

7898
32 DIS
Renault R18 Turbo



7708
32 TMMIA
32/35 TCICA



7737
35 CEEI



8077
32 DIS
Renault R5 - Super 5 GT



8076
32 IF
Renault R5 - R9 - R11



COPERCHIO CARBURATORE VETTURE TEDESCHE E INGLESI

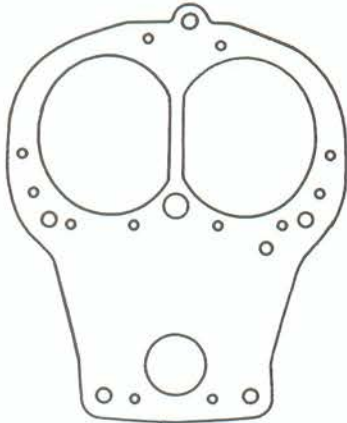

7208
Ford 17 M

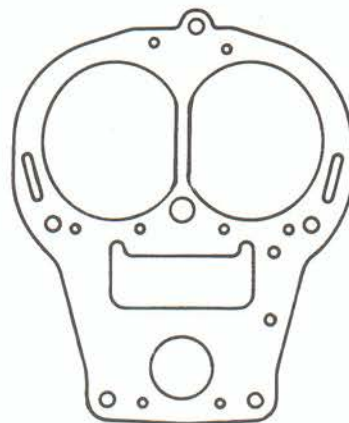

7227
Opel Rekord

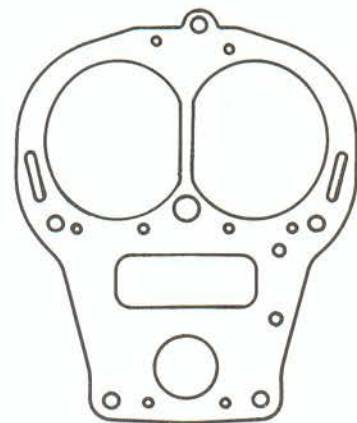

7263
Ford 17 M

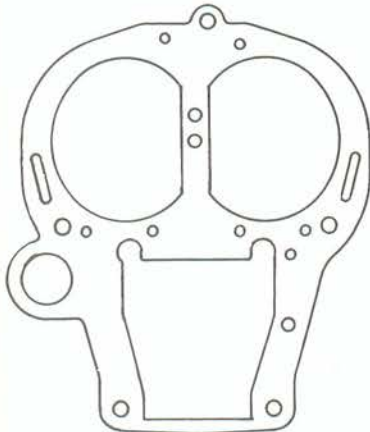

7423
Ford Taunus

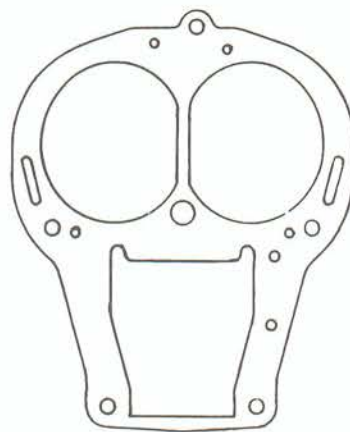

7460
Audi 100 - 100 LS

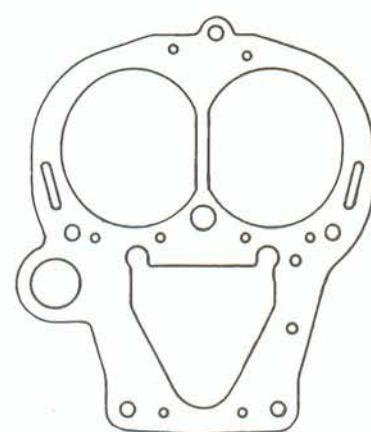

7461
Ford 20 M

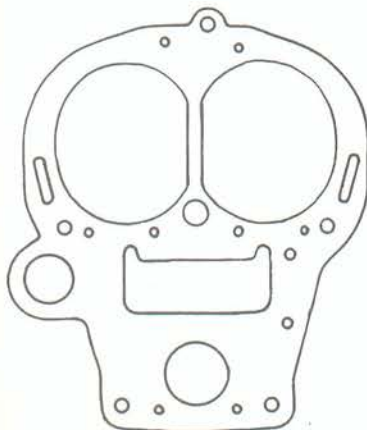

7494
Opel Manta - Kadett - Rekord



7538
Audi 80 GL - GLS

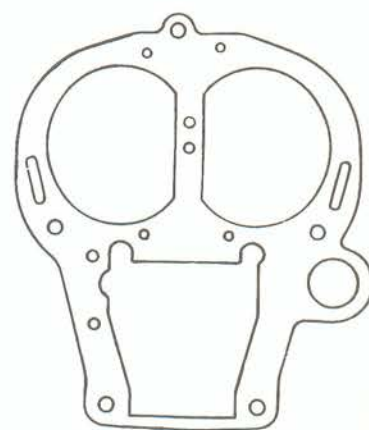

7539
Ford 17 M - 20 M



COPERCHIO CARBURATORE VETTURE TEDESCHE E INGLESÌ

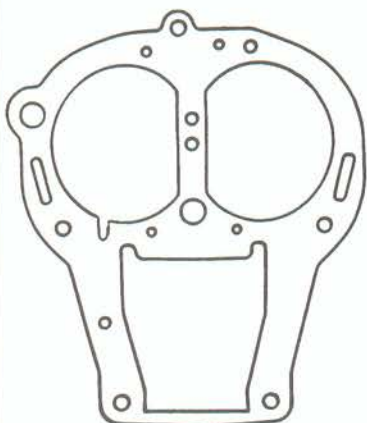

7610
Audi 80 GL - GLS

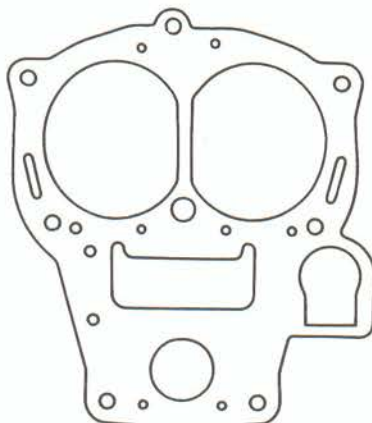

7691
Opel Manta

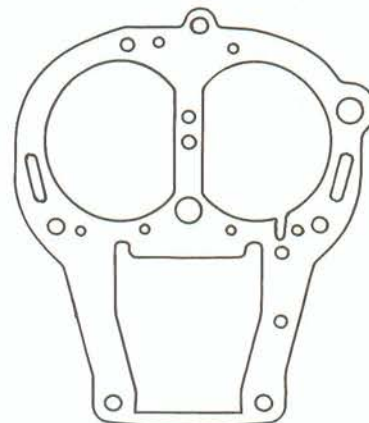

7722
32 DIDTA
BMW 316

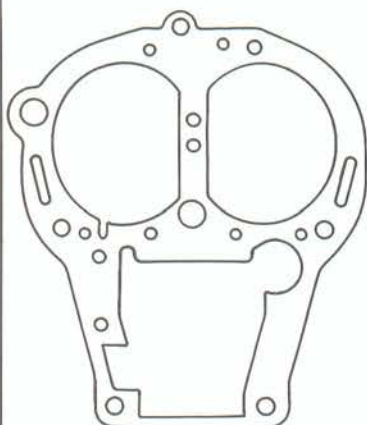

7794
32 DIDTA
BMW 316 - 318 - 320

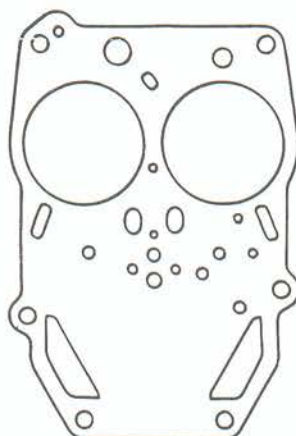

7599
Ford Capri 2300 GT



7956
38 EEIT
Ford Sierra 2,8



7665
30 IZ
Zenith

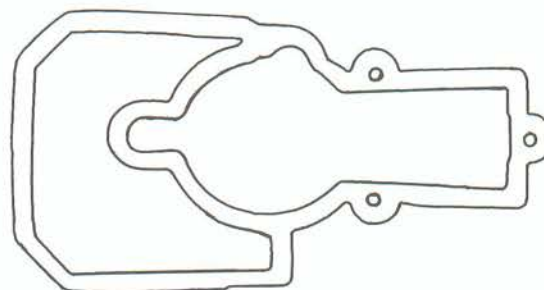

7797
Ford Nuova Escort
Carb. Motorcraft Venturi Variabile



COPERCHIO CARBURATORE VETTURE TEDESCHE E INGLESI

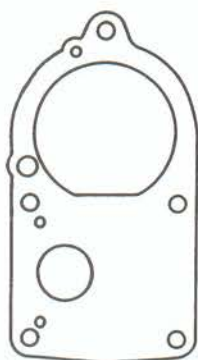

7098
28 PICT

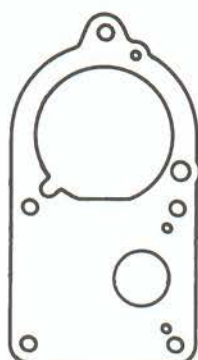

7287
30 PICT-1

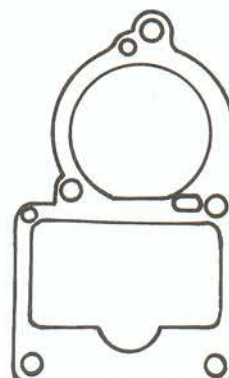

7290
30 PICT-2

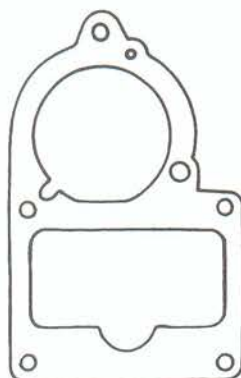

7495
30 PICT

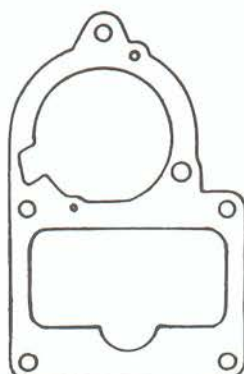

7496
31 PICT-3

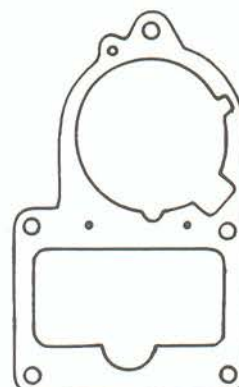

7497
34 PICT-3

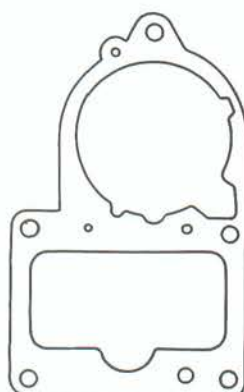

7775
34 PICT
VW Golf 1500

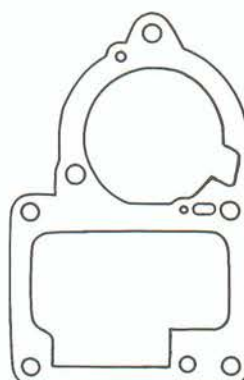

7932
31 PIC
VW Golf - Polo



COPERCHIO CARBURATORE VETTURE TEDESCHE E INGLESÌ

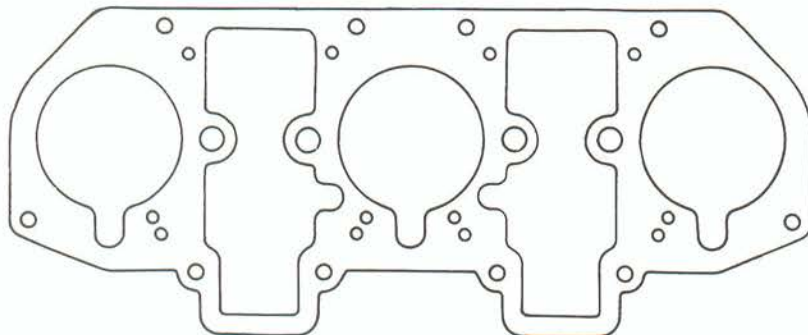

7400
WEBER 40 IDAP
Porsche 911

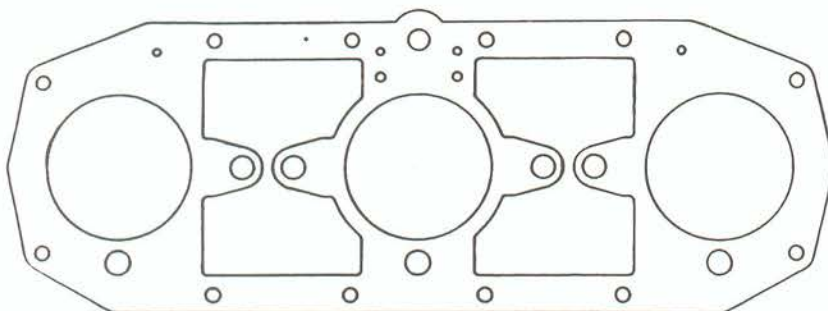

7477
Porsche Zenith

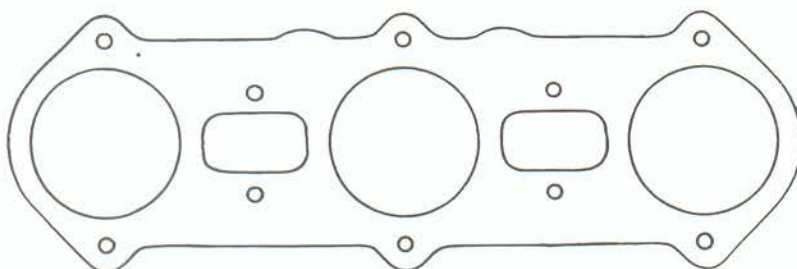

7478
Porsche Zenith

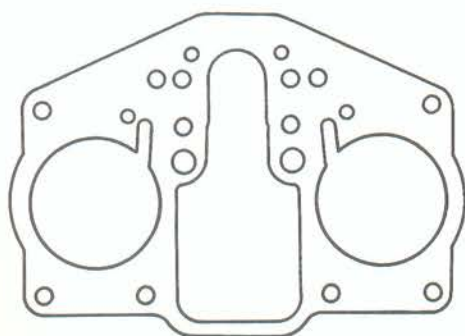

7149
SOLEX 44 PII
Porsche Carrera

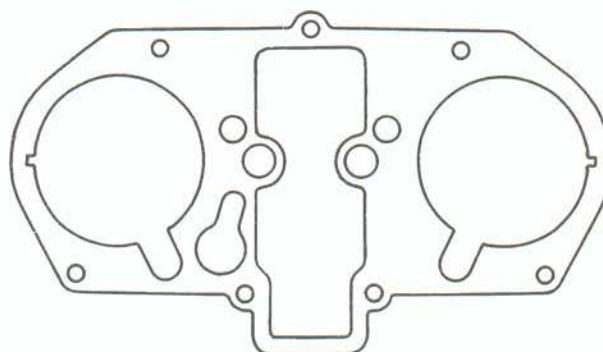

7179
WEBER 46/48 IDA
Porsche



COPERCHIO CARBURATORE VETTURE TEDESCHE E INGLES

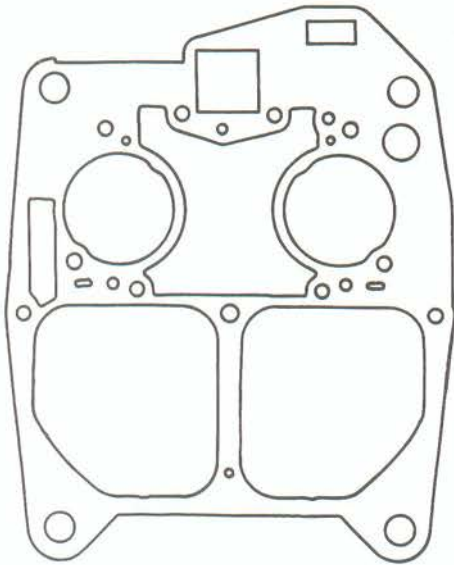

7631
Mercedes 350 - 450

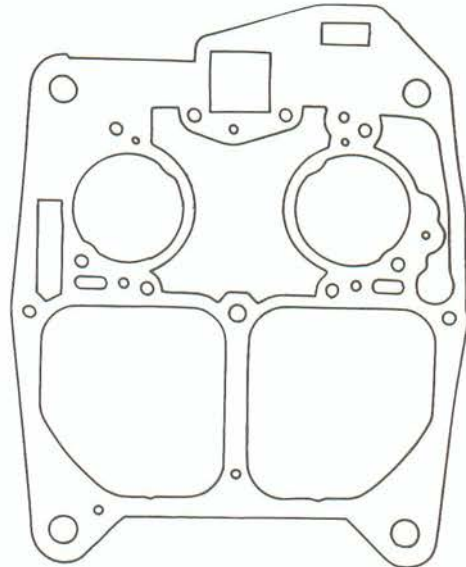

7723
ZENITH 4 A 1

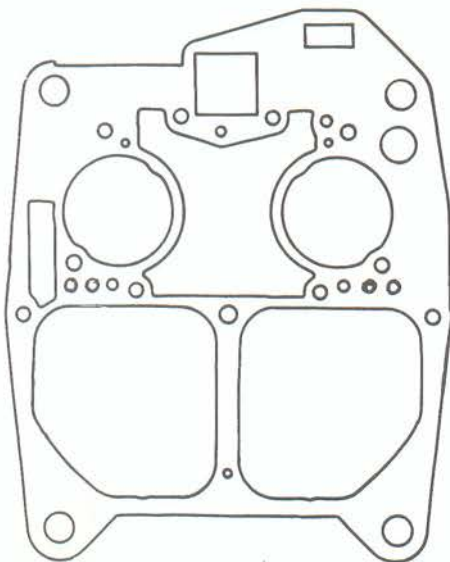

7805
4 A 1
Mercedes - BMW

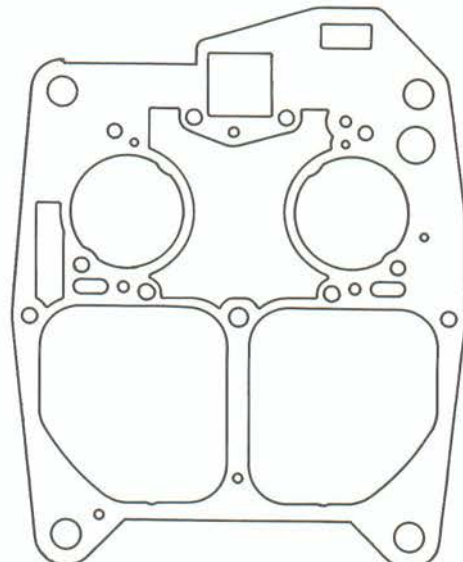

7927
4 A 1
Mercedes - BMW



COPERCHIO CARBURATORE VETTURE TEDESCHE E INGLESÌ

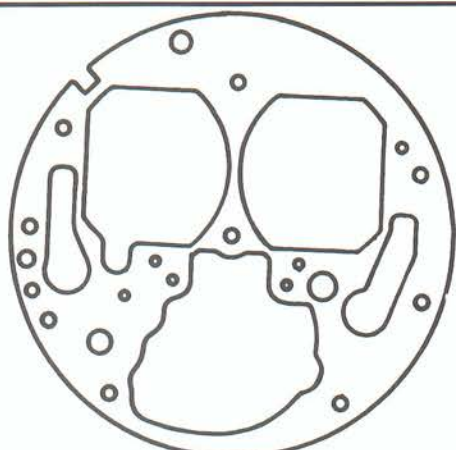

7341
35/40 INAT

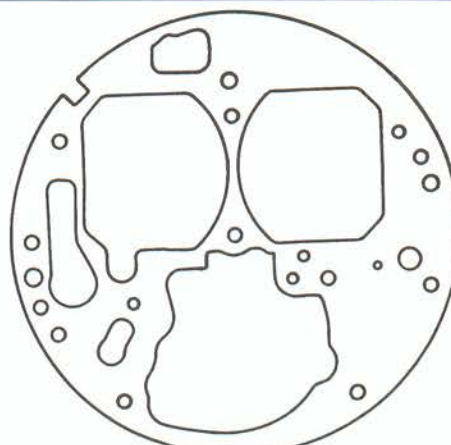

7633
32 V6 INAT

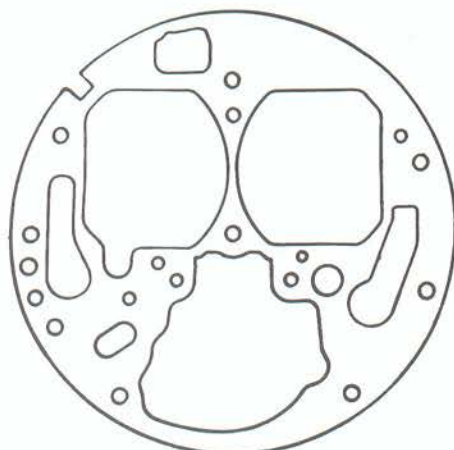

7634
35/40 INAT

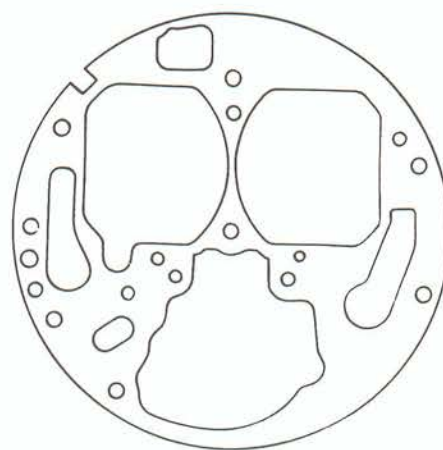

7664
35/40 INAT
BMW

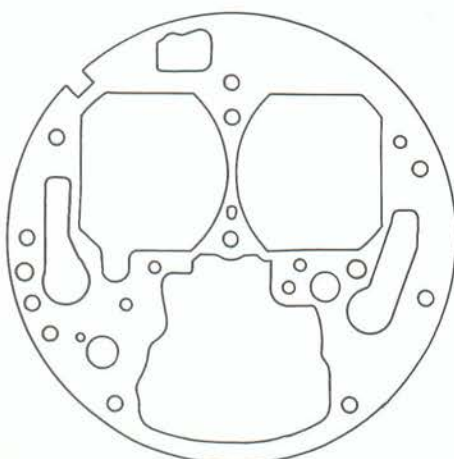

7815
35/40 INAT
Mercedes - BMW

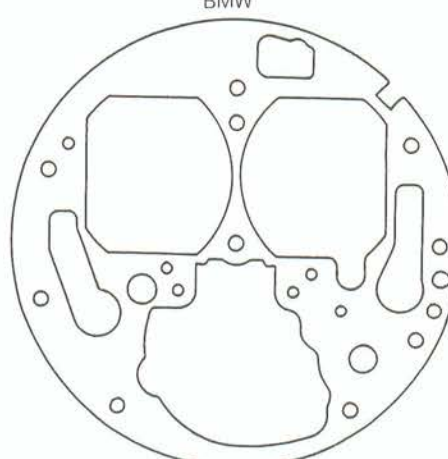

7942
35/40 INAT
BMW - Opel - Mercedes



COPERCHIO CARBURATORE VETTURE TEDESCHE E INGLESÌ

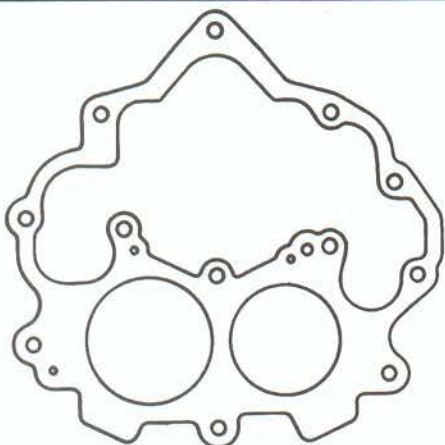

7340
35/40 INAT

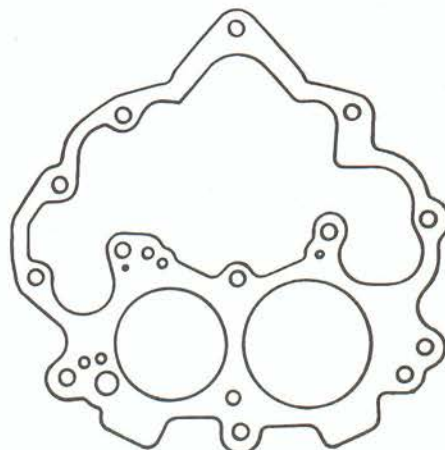

7632
32 V6 INAT
35/40 INAT

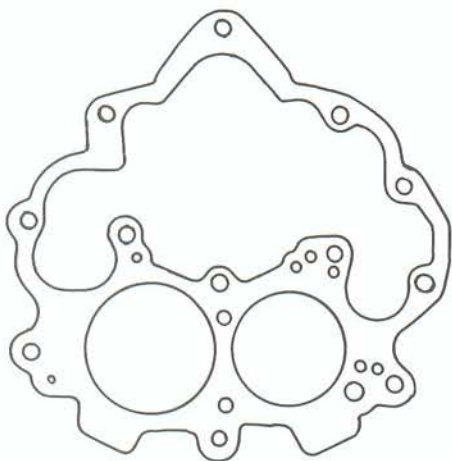

7728
35/40 INAT
BMW 525 - 528

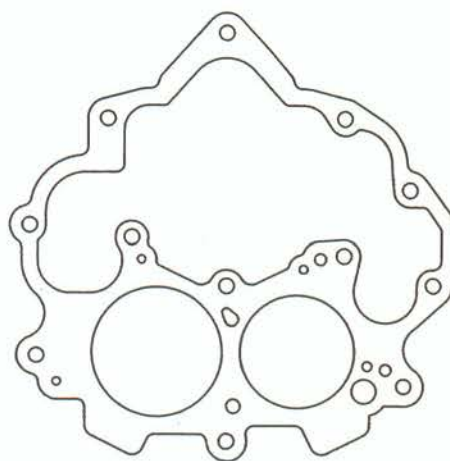

7960
35/40 INAT
Opel Ascona - Manta - Rekord

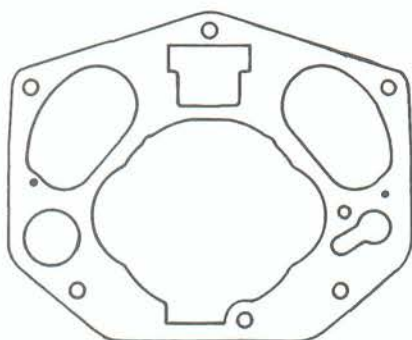

7481
ZENITH 32 NDIX
DKW 1000 - Porsche

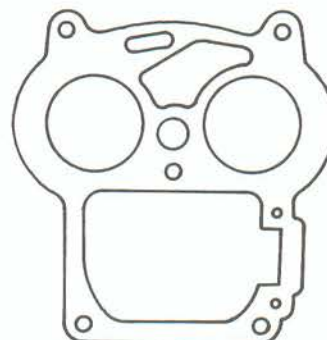

7261
Sunbeam



COPERCHIO CARBURATORE VETTURE TEDESCHE E INGLESÌ

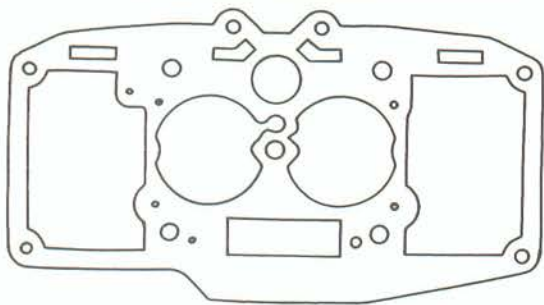

7658
ZENITH 2 B 2

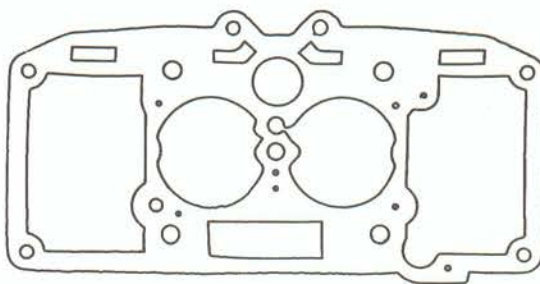

7701
ZENITH
VW Scirocco 1,6 TS

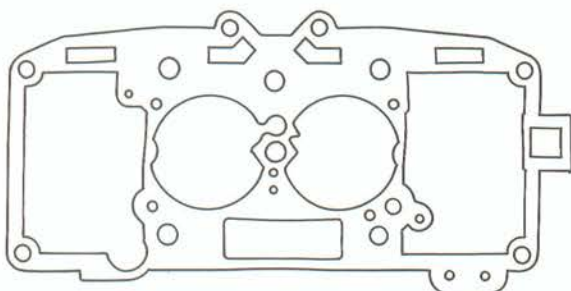

7824
2 B 2
BMW 316

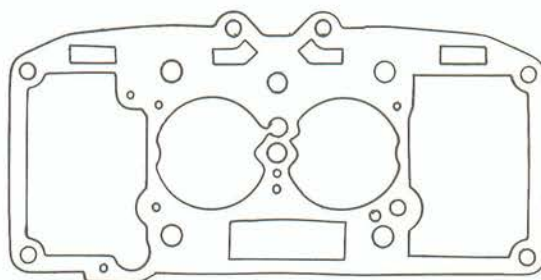

7908
2 B 2
BMW 316

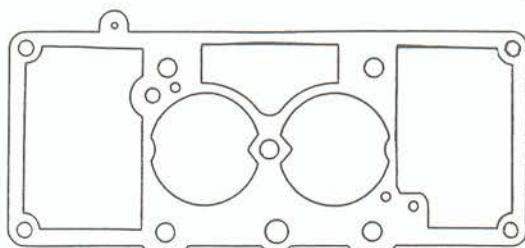

8079
34/34 2 B E (Ecotronic)
BMW 316

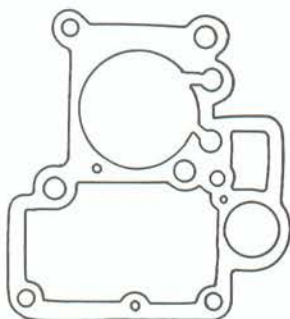

7830
36 1 B 1 - 1 B 3
Audi 80 GLS - VW Golf 1500

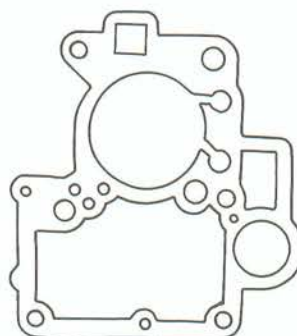

7880
36 1 B 2
BMW 315



COPERCHIO CARBURATORE VETTURE TEDESCHE E INGLESÌ

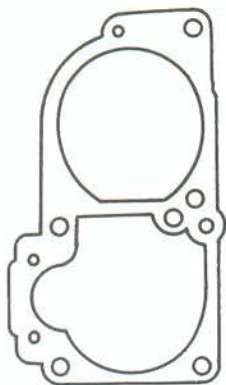

7134
28 PDSI

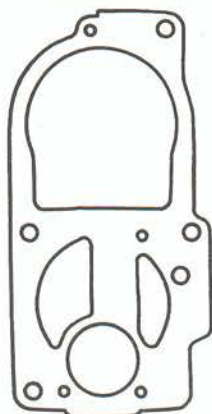

7162
32 PDSIT

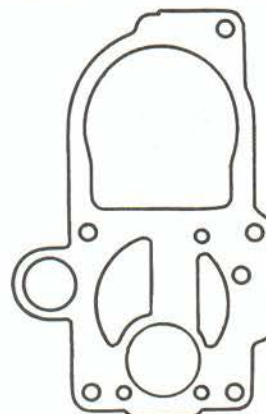

7170
28/32 PDSIT-4

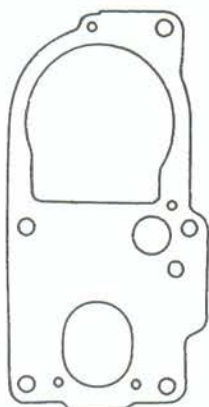

7214
35 PDSI-2

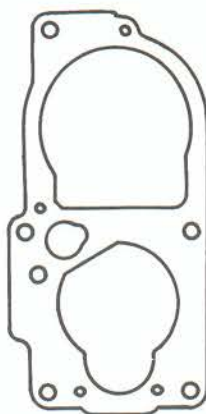

7233
35 PDSIT-2
Opel Kadett

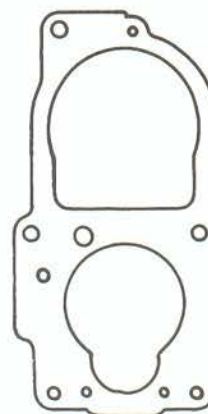

7234
32 PDSIT-2-3

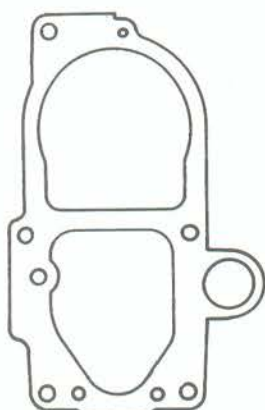

7236
32 PDSIT

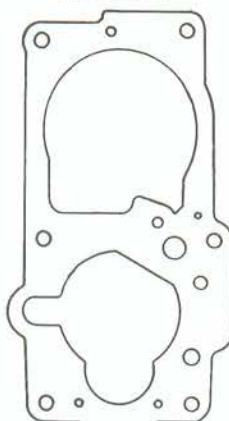

7440
Opel Kadett u.t.

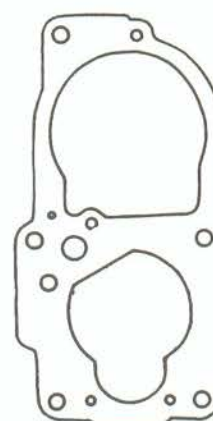

7485
SOLEX 35 PDSI
Opel Kadett



COPERCHIO CARBURATORE VETTURE TEDESCHE E INGLESÌ

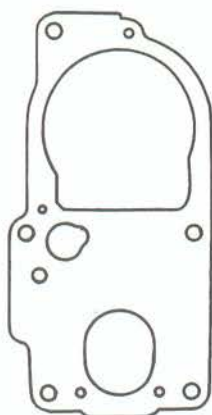

7504
SOLEX 35 PDSI
Opel Kadett

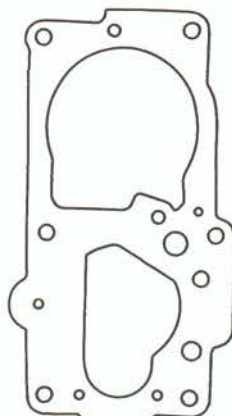

7689
35 PDSIT

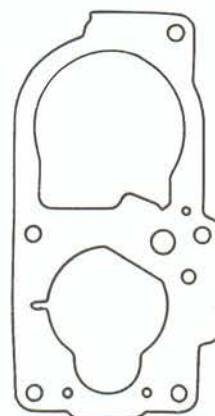

7750
Opel Kadett 1979

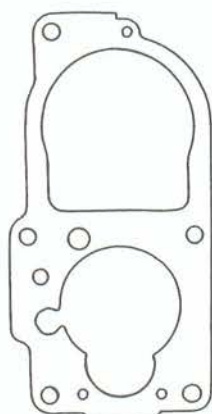

8061
35 PDST
VW Transporter

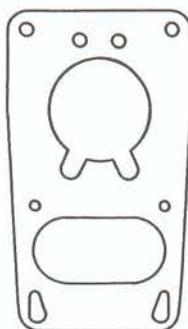

7083
34 PCI

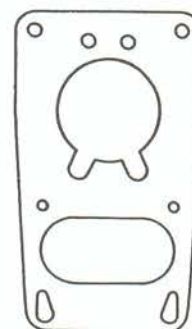

7085
28/32 PCI

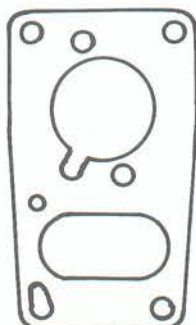

7348
28 PCI

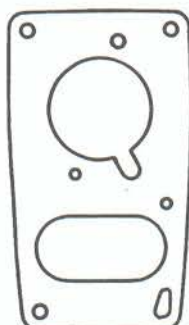

7195
34 PCI

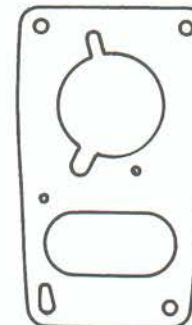

7286
34 PCI



COPERCHIO CARBURATORE VETTURE TEDESCHE E INGLES

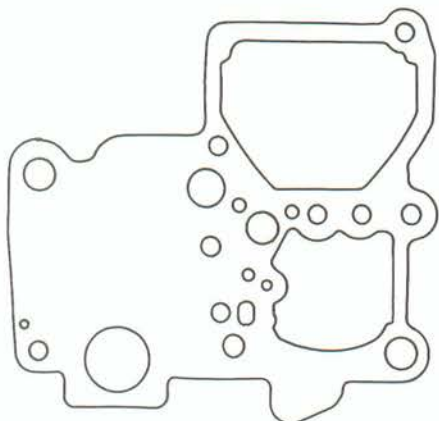

7821
Varajet
Opel Kadett 1,3

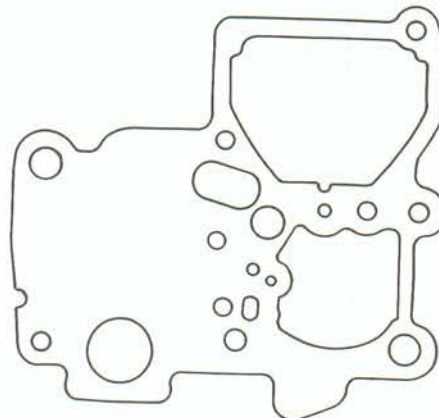

7822
Varajet
Opel Kadett 1,3

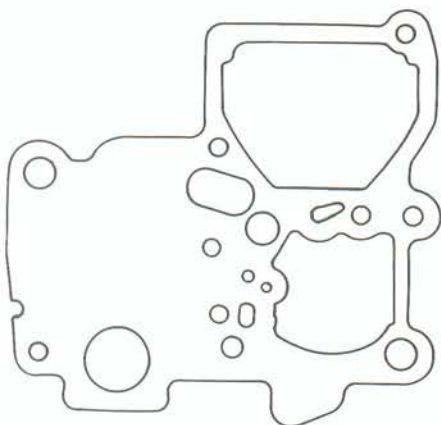

7844
Varajet
Opel Kadett 1,3 - 1,6

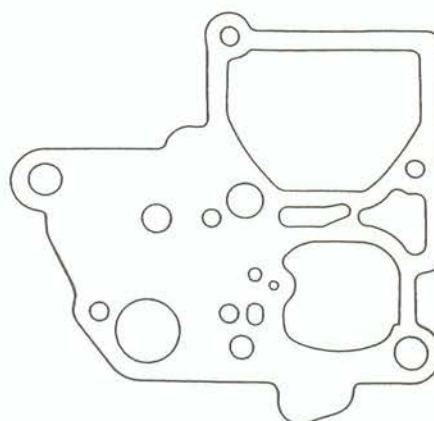

7852
Varajet
Opel Kadett 1,3 - 1,6

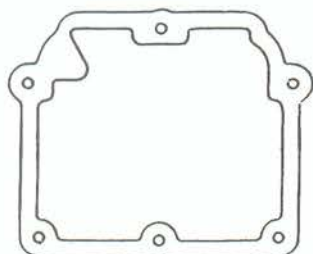

7465
Stromberg - Volvo

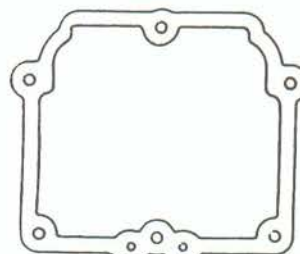

7474
Stromberg 175 CD



COPERCHIO CARBURATORE VETTURE TEDESCHE E INGLESÌ

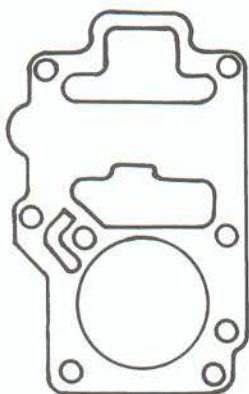

7334
FOMOCO
Ford Cortina

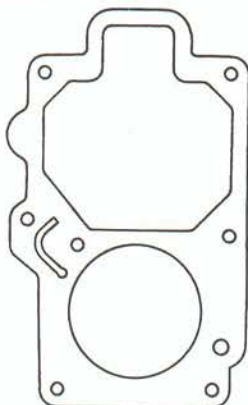

7418
FOMOCO

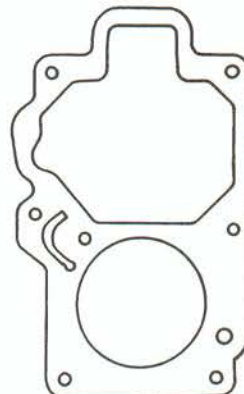

7452
FOMOCO
Ford

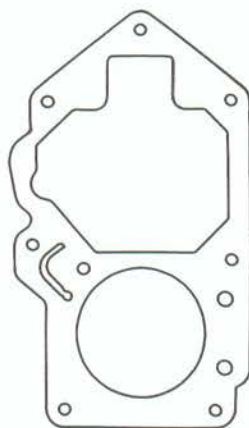

7651
FOMOCO
Ford Escort - Taunus

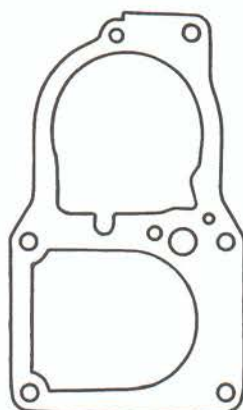

7168
BMW 1800 - 2000

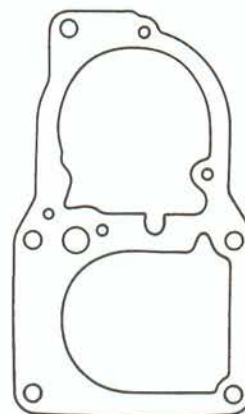

7629
BMW 2000 - 2002

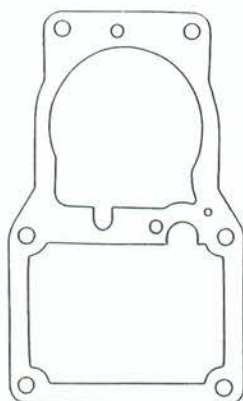

7948
36/40 PDSI
BMW 1602 - 2002 - 1502

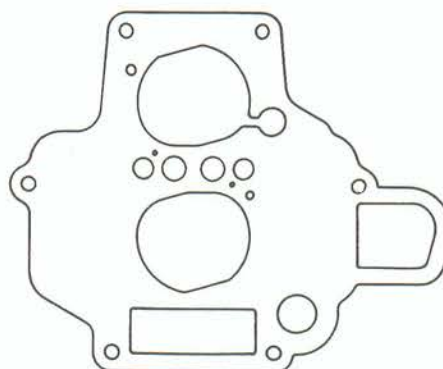

7715
32 DFT
Ford Fiesta



COPERCHIO CARBURATORE VETTURE TEDESCHE E INGLESI

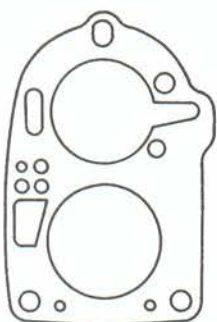

7105
32 PIC-B-A



7133
32 PICB



7284
32 PBI-C



7110
BMW 1800 TI

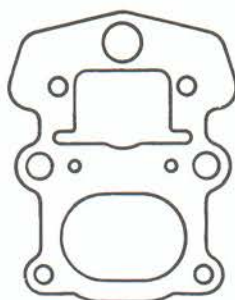

7376
BMW 2000 TI

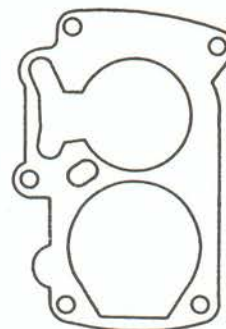

7122
30/33 PSEI

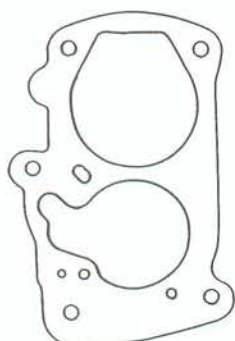

8068
30 IZ
Vauxhall Viva

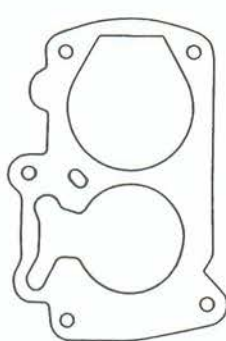

8069
30 IZ
Triumph Stag

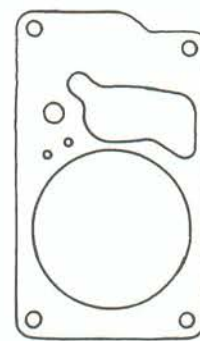

7499
SOLEX 40 PII
Porsche 911 1^a Serie



COPERCHIO CARBURATORE VETTURE TEDESCHE E INGLESI

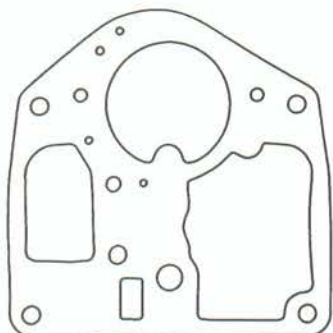

7615
ZENITH
Land Rover

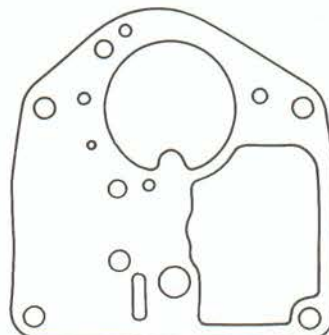

7837
ZENITH 36 IV
Land Rover

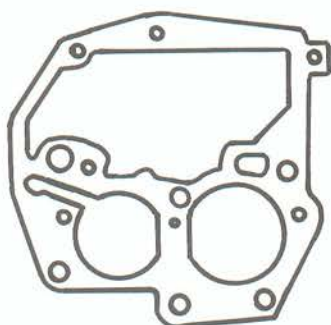

7897
28/30 2 E 2 - 2 E 3
VW Polo - Audi 80 GLS
Opel Kadett 1,3 LS - GL - GLS - GT



7132
JG S.U.
Innocenti Mini Minor

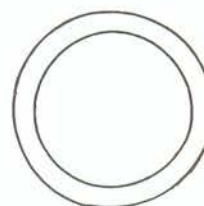

7454
S.U. HS 4
(Gomma)

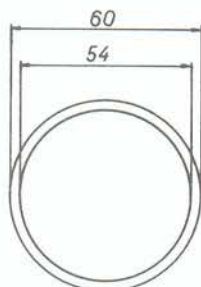

7291
S.U. HS 6

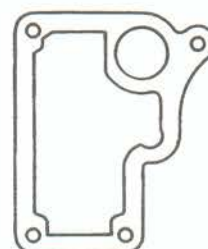

7199
KARTER
Opel Kadett



COPERCHIO CARBURATORE VETTURE TEDESCHE E INGLESI

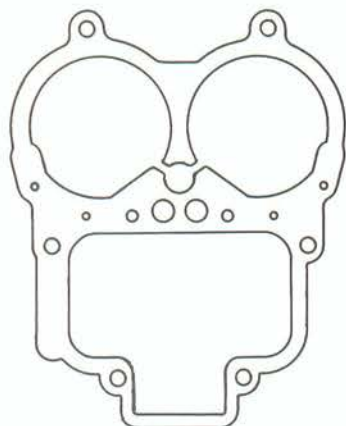

7515
32/36 DGAV
Ford Capri - Cortina

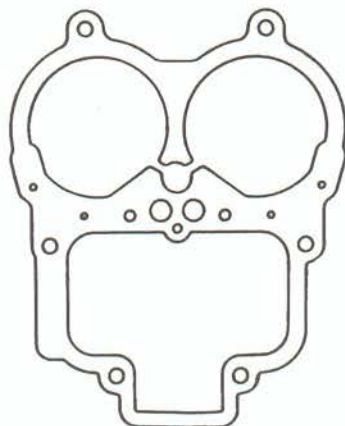

7516
32/36 DGAV
Ford Capri 1600 GT

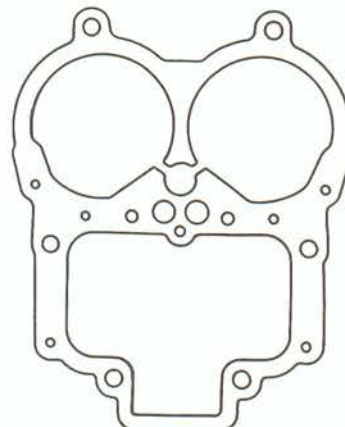

7840
32 DGAV
Ford Sierra

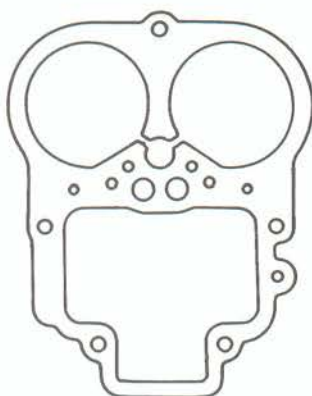

7407
32/36 DFV
Ford Capri 2000 GT

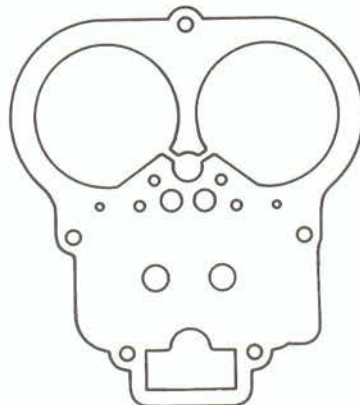

7408
40 DFA
Ford Zodiac

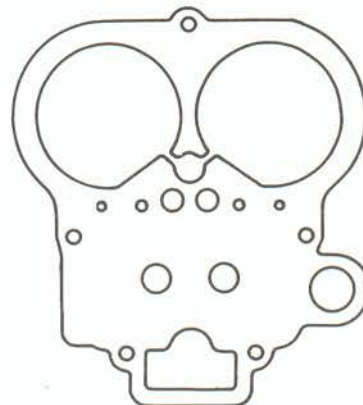

7409
40 DFAV
Ford Zodiac

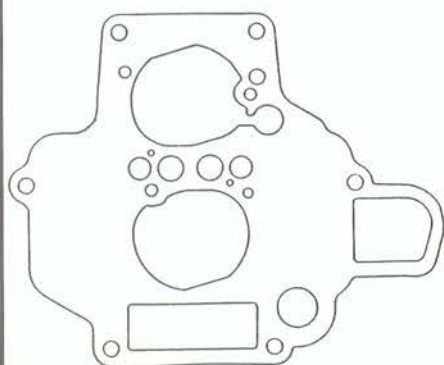

7981
32 DFT
Ford Fiesta 1300 - 1600

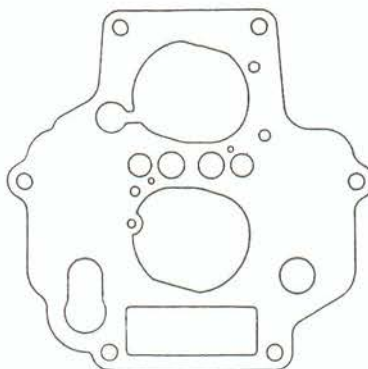

8126
32 DFT
Ford Sierra - Skorpio

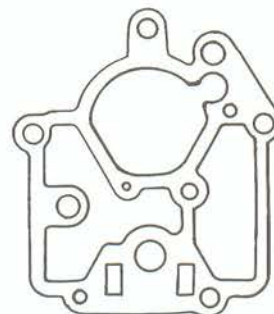

7901
32 TL 250
Opel Corsa



INTERMEDIE VETTURE TEDESCHE E INGLES

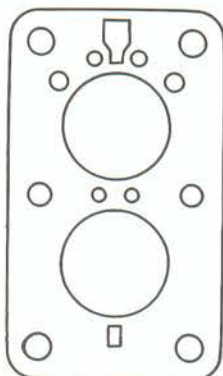

7755
32 DIDTA
BMW 316 - 320

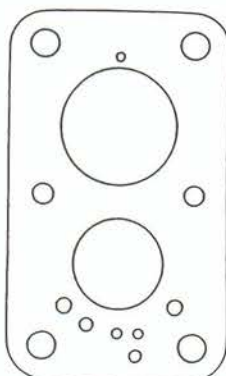

7558
Ford 17M - 20M
Simca 1301 Special

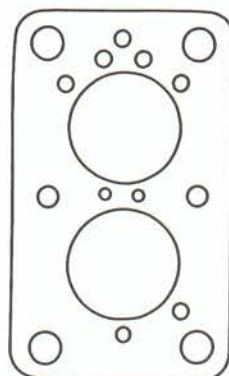

7686
BMW 316 - 318 - 320

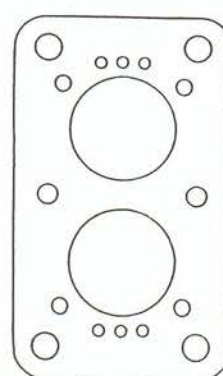

7256
32 PDIST
Ford 20M

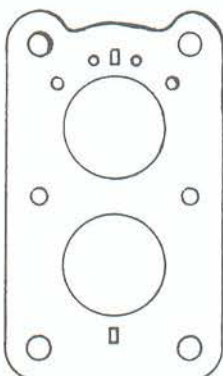

7471
Opel Ascona - Manta
Audi

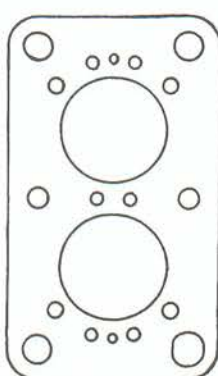

7498
Ford Capri 17M

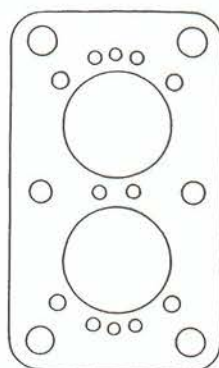

7542
32 TDID
Ford Taunus Granada

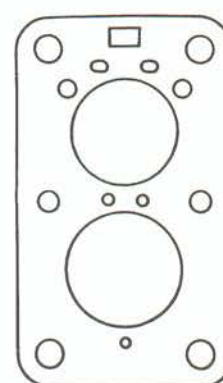

7605
Audi 80 GL

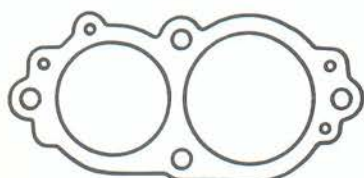

7613
35/40 INAT
BMW - Opel - Mercedes

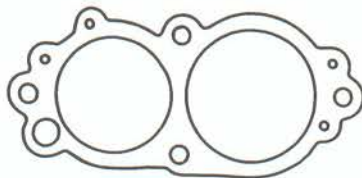

7667
ZENITH 35/40 INAT



7688
ZENITH 40 INAT



INTERMEDIE VETTURE TEDESCHE E INGLESI

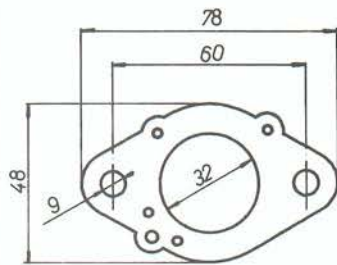

7237
32 PDSIT-2-4-7

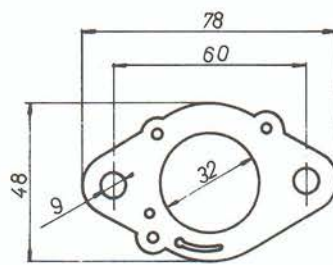

7238
32 PDSIT-3-7

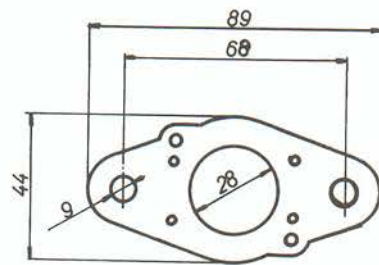

7240
28 PDSI

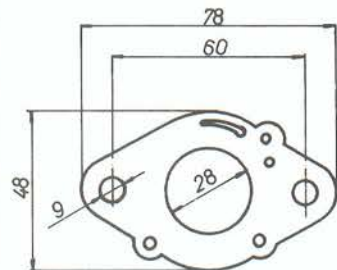

7251
28 PDSIT-7

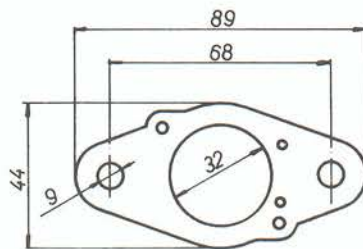

7252
32 PDSI

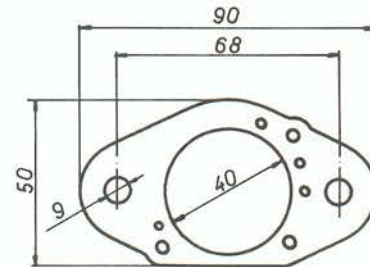

7253
36/40 PDSIT
BMW 2000

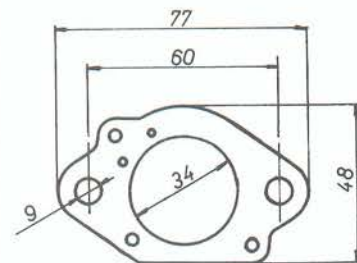

7239
35 PDSI-1-2

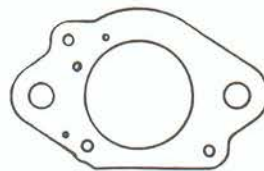

7479
Opel Kadett

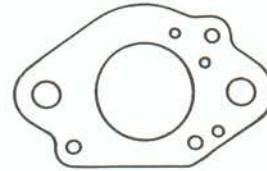

7751
Opel



8072
35 PDSIT
Volkswagen - Opel

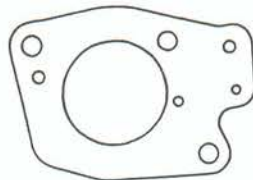

8071
32 TL
Opel Kadett 1,2 S - Corsa 1,2

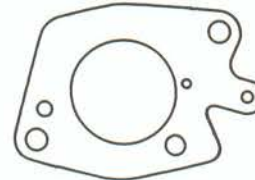

7885
32 TL 250
Opel Corsa



INTERMEDIE VETTURE TEDESCHE E INGLESÌ

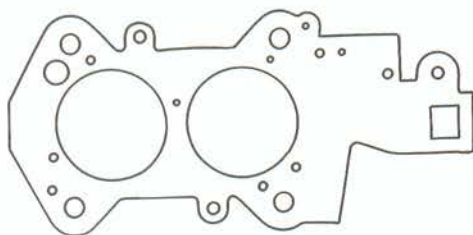

7823
36 2 B 2

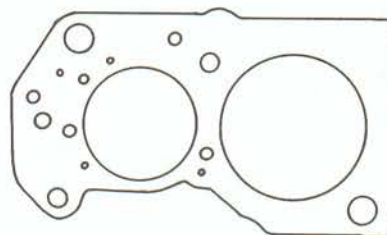

7836
Varajet
Opel Kadett 1,3 SR

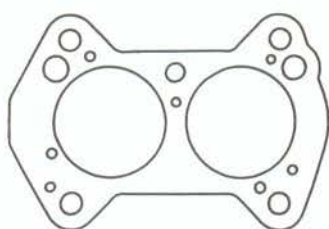

7684
Audi 100 GLS
VW Scirocco - Golf 1500

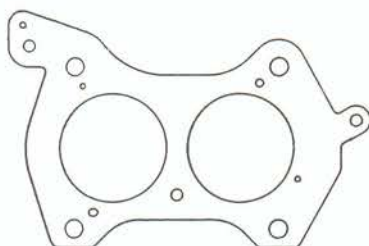

8078
34/34 2 B E
BMW 316

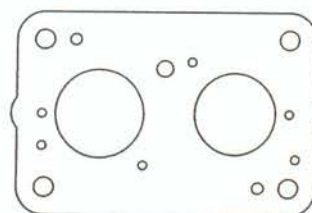

7990
26/28 TLDM
Ford Fiesta

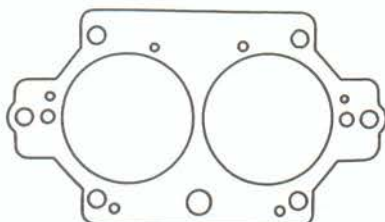

7687
38 EEIT

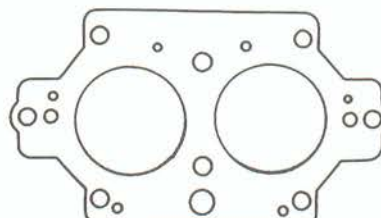

8118
35 EEIT

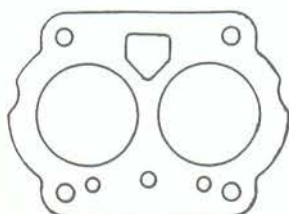

7482
ZENITH 32 NDIX
BMW - Porsche

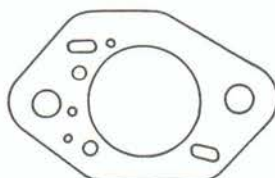

7685
Opel Kadett u.t.



7211
Opel Kadett



ATTACCO CARBURATORE VETTURE TEDESCHE E INGLESI

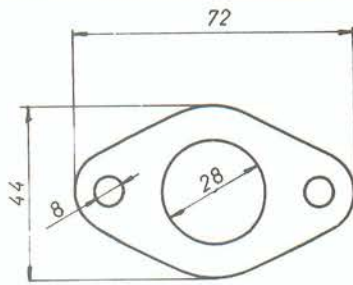

7310
Volkswagen 1200

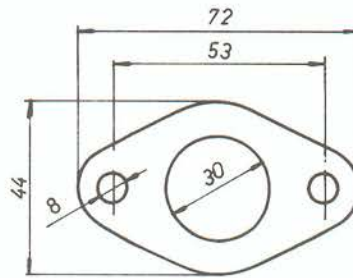

7311
Volkswagen 1300

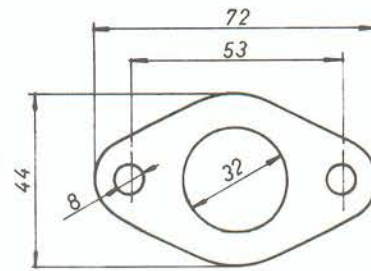

7312
Volkswagen 1500

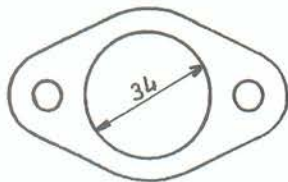

7584
Volkswagen Maggiolino

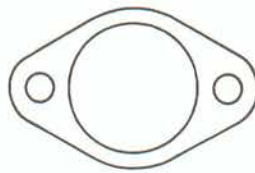

7414
NSU Prinz

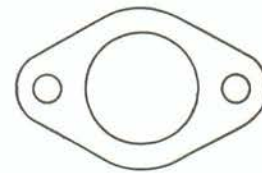

7414 B
NSU Prinz

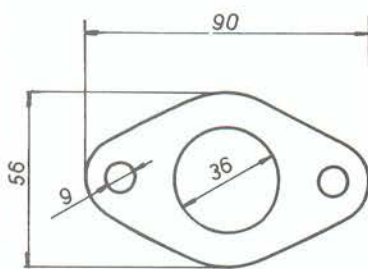

7304
BMW 1600

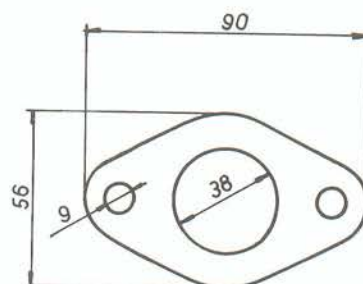

7305
BMW - Opel

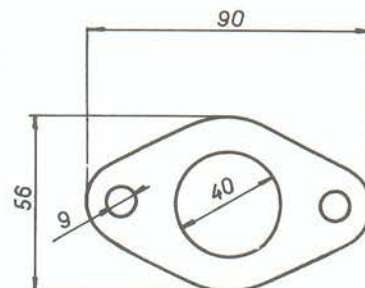

7306
BMW 2000

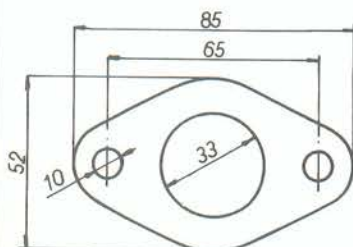

7241
S.U. HS 2

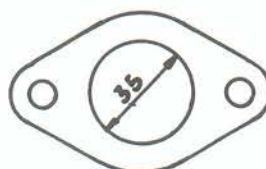

7377
35 PDSIT-6

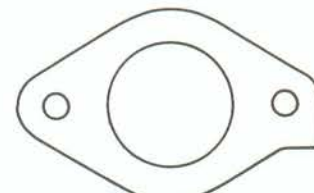

7447
Ford Escort



ATTACCO CARBURATORE VETTURE TEDESCHE E INGLESI

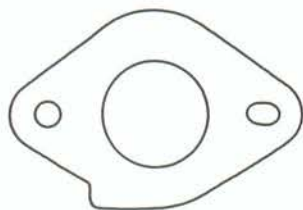

7718
Ford Fiesta

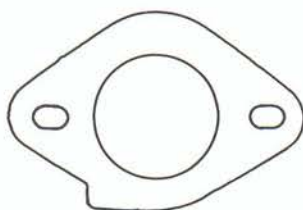

7854
Ford Fiesta 1,0 C
Festival - Holiday - Friend

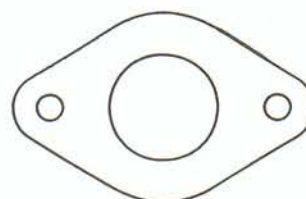

7420
FOMOCO
Ford Escort

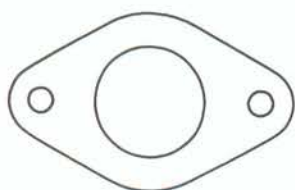

7642
VW Golf - Scirocco
Maggiolino - Maggiolone

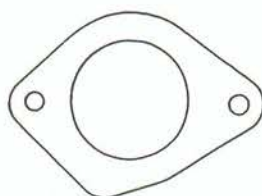

8052
36 1 B 3
Audi 80

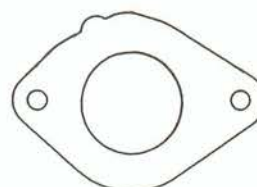

7911
32 TL
Opel Corsa

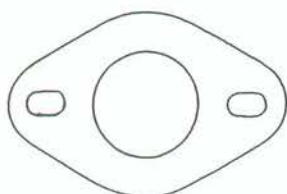

8063
S.U. - HS 4
Austin - Hillman - Innocenti
MG - Morris - Triumph

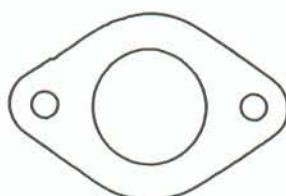

7670
VW Golf - Scirocco - Polo Coupé

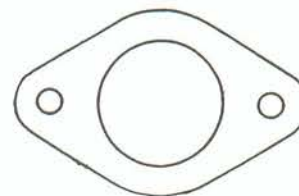

7463
Stromberg - Volvo

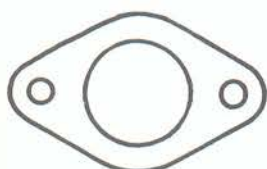

7362
Ford C6

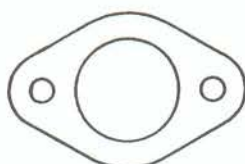

7526
Volkswagen 1500

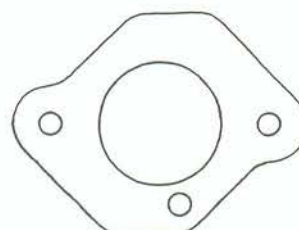

8065
S.U. - HIF 6
Leyland - Innocenti



ATTACCO CARBURATORE VETTURE TEDESCHE E INGLESÌ

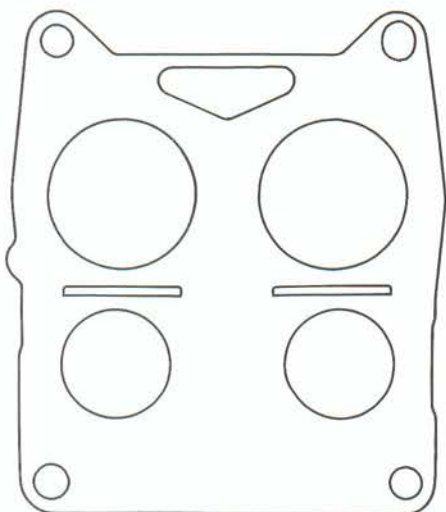

7813
4 A 1
BMW - Mercedes - Opel

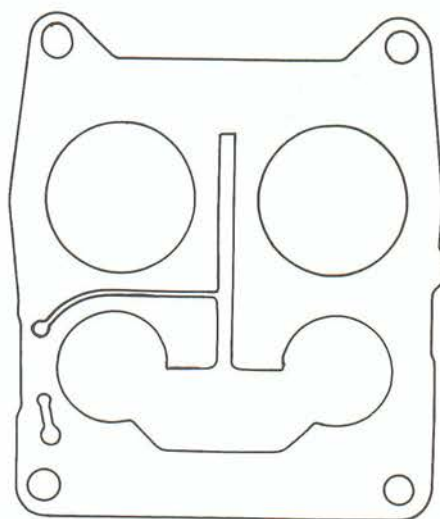

7814
4 A 1
BMW - Mercedes - Opel

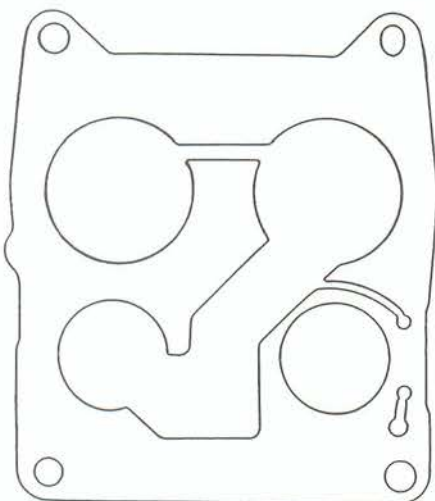

7817
4 A 1
BMW - Mercedes - Opel

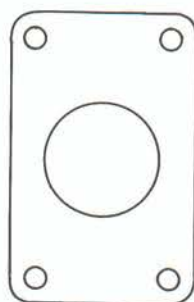

7731
VW Scirocco 1600
Golf 1500

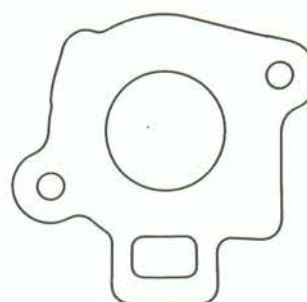

7851
Varajet
Ford Escort



8045
28/32 E3
VW Polo Coupé - Passat



8096
Opel Kadett 1300 GLS

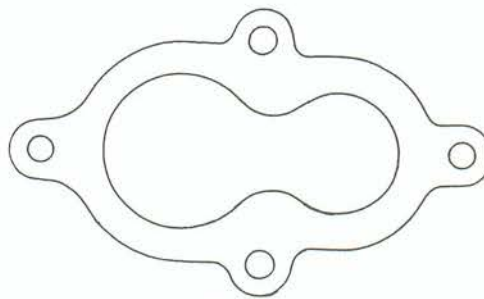

8122
Opel Ascona



ATTACCO CARBURATORE VETTURE TEDESCHE E INGLESÌ

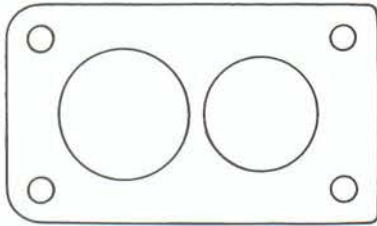

7720
Audi 80 - 100

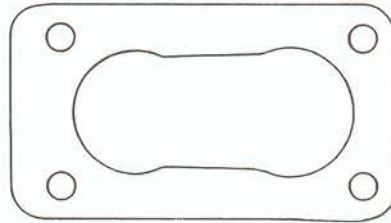

7566
Ford Capri 2600

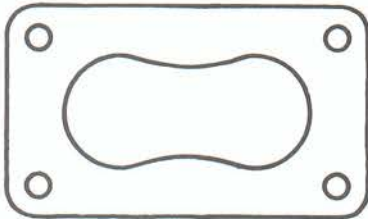

7360
32/35 DDIST

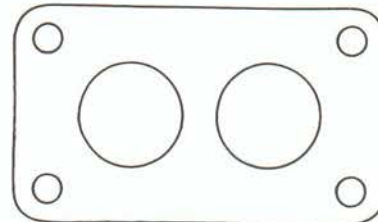

7930
32 DIDTA 2/4
Opel 1,9

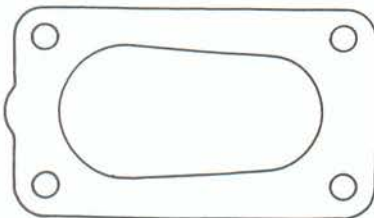

7630
Opel Commodore 2,5

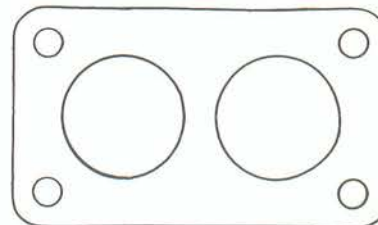

7719
Audi 80 - 100 - 85 CV 1588 cc.

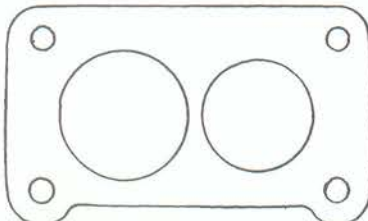

7534
BMW - Opel - Mercedes

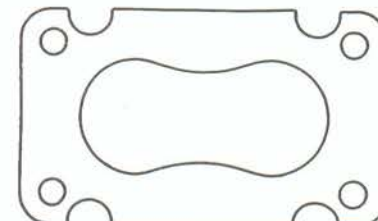

7668
Opel Ascona - Manta - Rekord



ATTACCO CARBURATORE VETTURE TEDESCHE E INGLESÌ

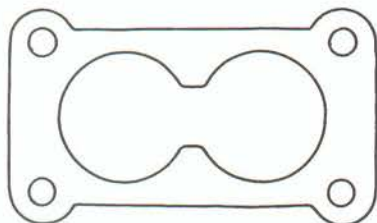

7628
35/40 INAT

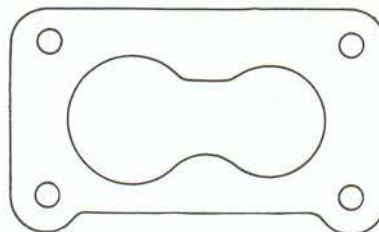

7717
ZENITH 35/40 INAT

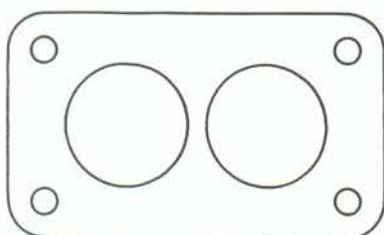

7598
Ford Capri 2300 - 2600 GT

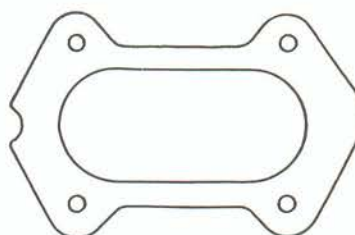

7752
Volkswagen Scirocco

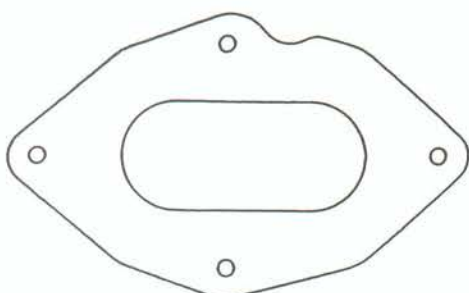

7753
Volkswagen Scirocco

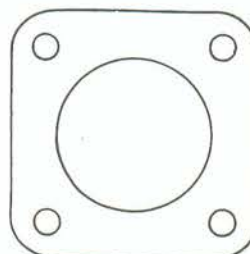

7573
S.U. - Stromberg - Volvo

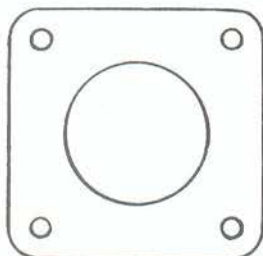

7637
ZENITH 175 CDT - CDET
BMW - Mercedes

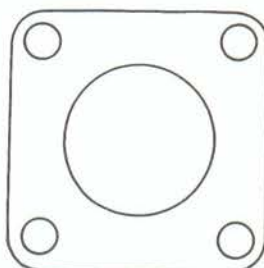

7638
STROMBERG 175 CDT

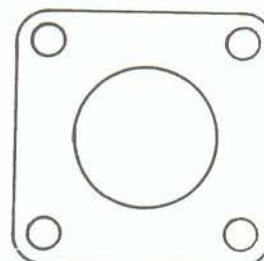

7666
STROMBERG 175 CDIT
BMW 520
Mercedes 200 - 220



ATTACCO CARBURATORE VETTURE TEDESCHE E INGLESI

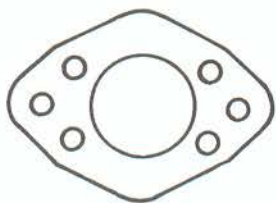

7298
S.U. HS 2

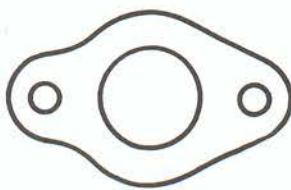

7355
S.U. HS 2 u.t.

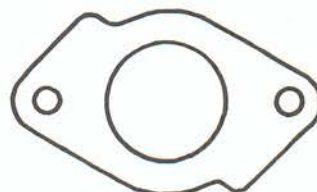

7378
S.U. HS (Potenziato)

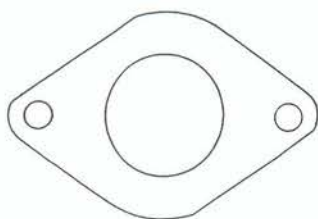

7507
VW Maggiolino

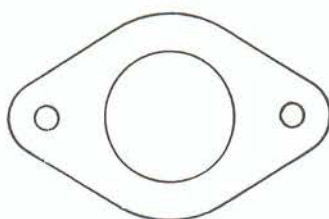

7536
SOLEX 40 TIN
Porsche

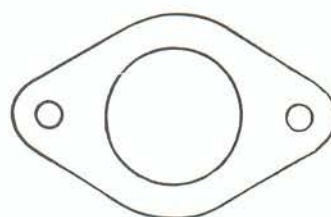

7537
VW K 70

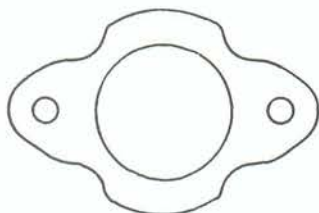

7456
VW K 70

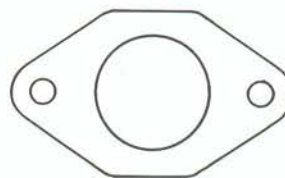

7928
31 PIC - 34 PICT
VW Golf 1100 cc.

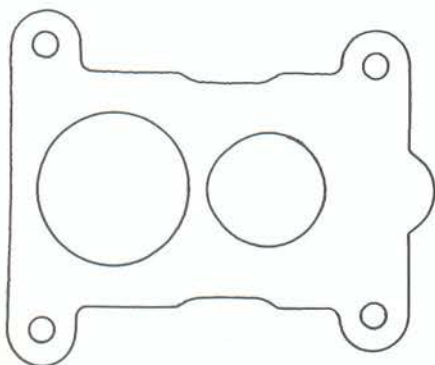

7816
VARAJET
Opel Kadett 1,3 - 2,0

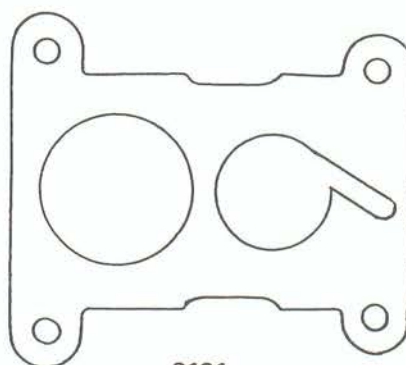

8121
VARAJET
Opel Kadett



INTERNE VETTURE TEDESCHE E INGLESI



7342
35/40 INAT



7343
35/40 INAT



7344
35/40 INAT



7345
35/40 INAT



7677
ZENITH
35/40 INAT

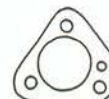

7965
150 CD
Chrysler
Hunter 1725

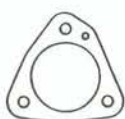

7549
Audi

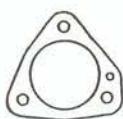

7946
35 PDSIT-5
Audi 80S-LS 1500 cc.



7818
35/40 INAT
BMW - Opel - Mercedes



7142
32 PDIST

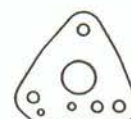

7951
32 DIDTA
BMW 2002 - 316 - 318
318 aut. - 320 - 320 aut.



7597
32/34 EIES



7433
46 IDA



7472
STROMBERG



7473
STROMBERG



7647
175 CDT
STROMBERG



7636
175 CDT
STROMBERG



7726
ZENITH 4 A 1



7727
ZENITH 4 A 1



7895
4 A 1
BMW 320

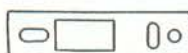

8073
Opel



7839
4 A 1
BMW 525-528-630



7925
4 A 1
BMW 733



8013
2 E 3
VW Polo Coupé



8010
2 E 3
VW Polo Coupé



8012
2 E 3
VW Polo Coupé



INTERNE VETTURE TEDESCHE E INGLES

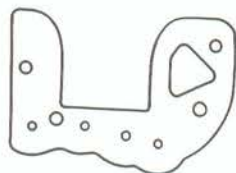

7855
Venturi Variabile
Ford Escort



7856
Venturi Variabile
Ford Escort

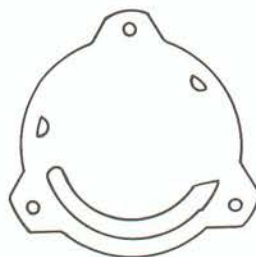

7879
Venturi Variabile
Ford Nuova Escort

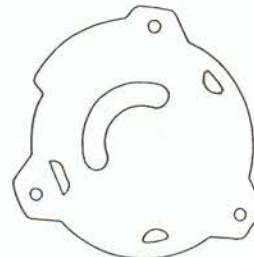

8123
Venturi Variabile
Ford Nuova Escort
Starter manuale



7891
36 1 B 2
BMW 315



7892
36 1 B 2
BMW 315



7829
36 1 B 1 - 1 B 3
Audi - BMW - VW



8124
Austin Rover

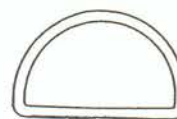

7945
35 PDSIT-5
Audi 80 S - LS
1500 cc.



7108
34 PCI



7296
40 PII

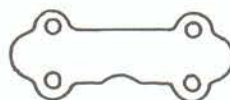

7288
40/44 PHH



7646
ZENITH
32 V6 INAT



7955
175 CDT
Mercedes
200 - 220



7421
Ford Capri



7958
35 PDSI
Opel
Kadett 1,2 S



7894
36 1 B 2
BMW 315



7893
36 1 B 2
BMW 315



7961
35/40 INAT
Opel Ascona
Manta



7952
32 DIDTA
2002 - 316 - 318 - 320
BMW



7953

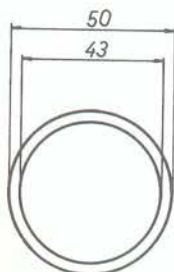

7250
32 PDSIT

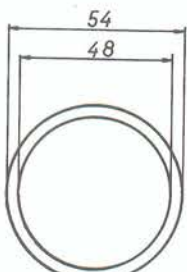

7235
32 PHN



7947
35 PDSIT
Audi 80 S



7679
Ford Fiesta 900 - 1000



ATTACCO FILTRO VETTURE TEDESCHE E INGLES

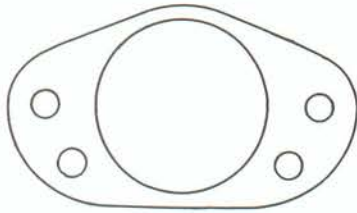

7807
Austin Rover

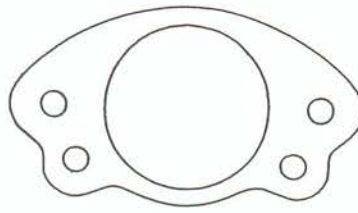

8030
S.U. HD 8
Aston Martin - Daimler
Jaguar - Rover

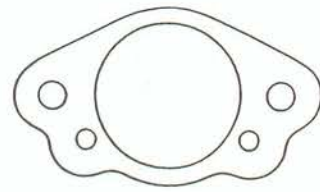

8064
S.U. HS 6
Austin - Innocenti - Jaguar
MG-Morris - Rover
Triumph - Volvo



7381
S.U. HS

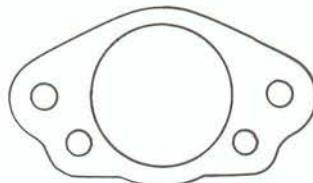

7811
S.U. HS 8
Land Rover

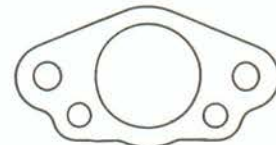

7810
S.U.
Land Rover

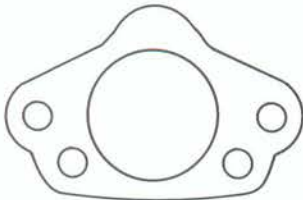

7863
S.U.
Mini 90

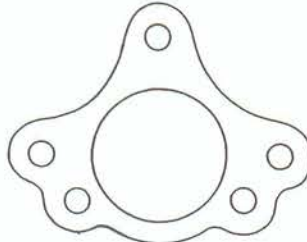

8015
S.U. HS 6
Austin - Innocenti - Jaguar
MG-Morris - Rover
Triumph - Volvo

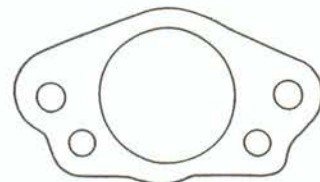

8018
S.U. HS 6
Austin - Innocenti - Jaguar
MG-Morris - Rover
Triumph - Volvo

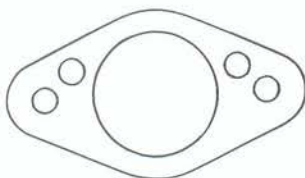

7869
S.U.

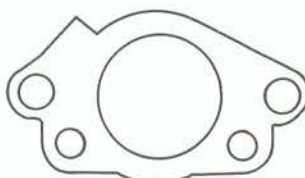

7790
S.U. HS 4
Mini

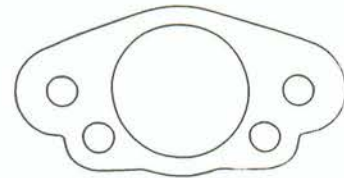

7995
S.U. HS 6
Mini Cooper



ATTACCO FILTRO VETTURE TEDESCHE E INGLESÌ

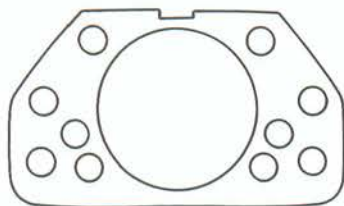

7791
S.U. HS 8
Rover



7758
S.U. HS 6
Austin Rover

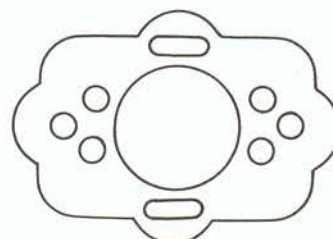

7789
S.U.
Regent - Rover - Jaguar

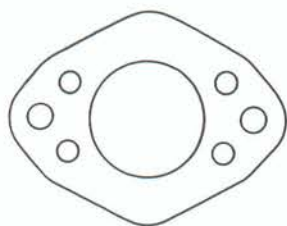

7676
S.U. HS 6

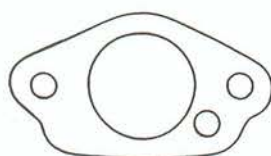

8062
S.U. HS 4
Austin - Hillman - Innocenti
MG-Morris - Triumph

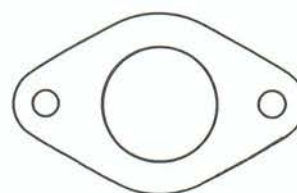

7838
36 IV
Land Rover

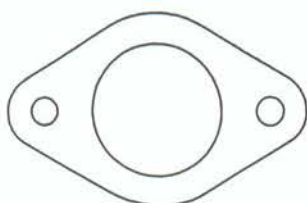

7954
175 CD 2 SE
Volvo B 18 A

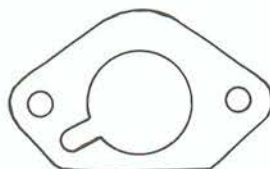

7416
S.U. HS 2

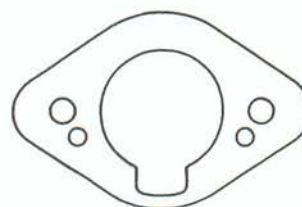

7464
STROMBERG
Volvo

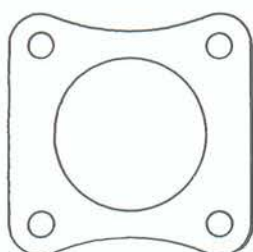

7802
S.U.
Mini 120

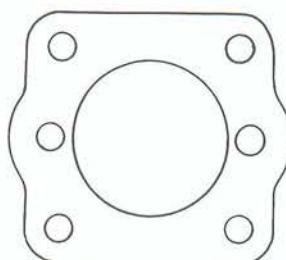

7907
175 CDUS
Volvo

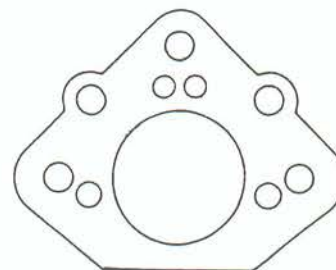

8125
S.U.
Range Rover



VARIE

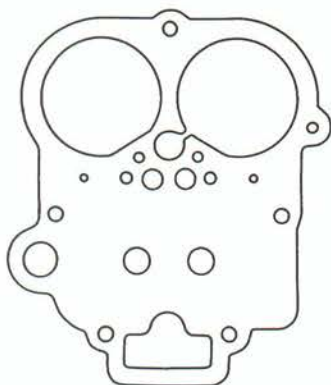

7649
32 DGR
ZAZ - ZIGULI - LADA

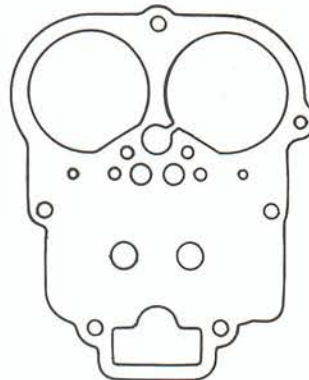

7757
ZAZ - ZIGULI - LADA

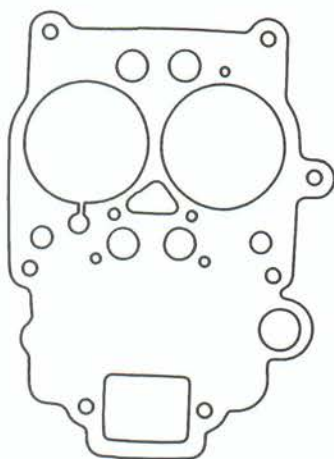

7724
Skoda 100 LS

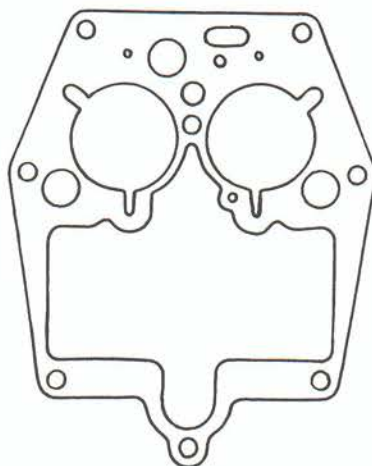

7576
Skoda 1100 Coupé

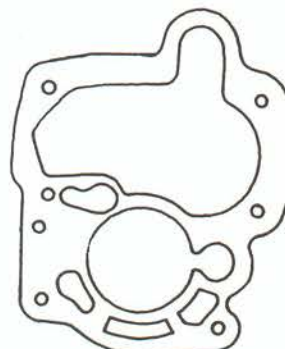

7500
Skoda 1100



7575
Skoda 1100



7562
Skoda 1100



7563
Skoda 1100



7849
175 CDUS
Volvo 244



VARIE

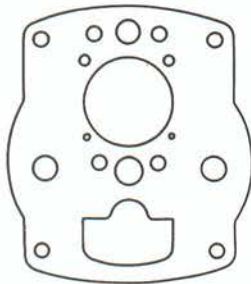

7702
Motozappa Lombardini

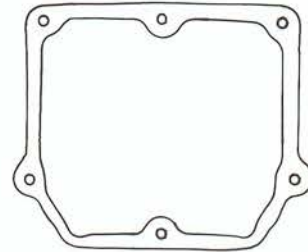

7850
175 CDUS
Volvo 244

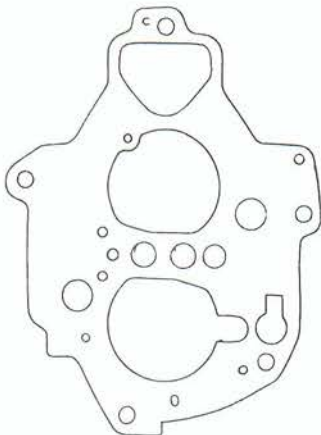

8120
28/34 Z 10
Lada Samara

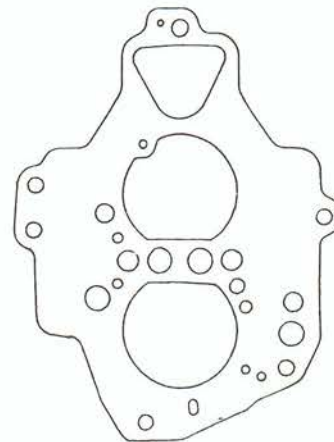

8119
28/34 Z 10
Volvo 360



VARIE

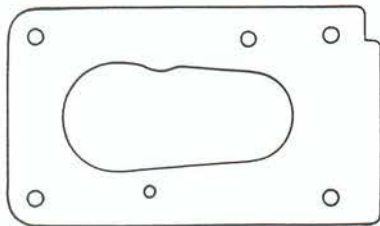

8081
28/34 Z 10
Volvo 360
Renault R 21



7812
36 IV
Land Rover



7949
36 ELLER
36 VN
Volvo B16 - B18 A



8031
S.U. HD 8
Aston Martin
Jaguar - Rover

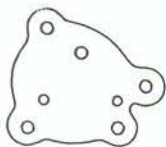

7847
150 CD
Chrysler Hunter 1725
Triumph Stag
Vauxhall Firenza



8021
150 CD
Chrysler Hunter 1725
Triumph Stag
Vauxhall Firenza



7843
150 CD
Chrysler Hunter 1725
Triumph Stag
Vauxhall Firenza



8032
S.U. HIF 44
Austin Leyland
MG-Morris
Rover - Volvo



7841
CD - CDT



7842
CD - CDT



7906
CD - CDT



7916
CD - CDT



7917
CD - CDT



7918
CD - CDT



COPERCHIO CARBURATORE VETTURE GIAPPONESI

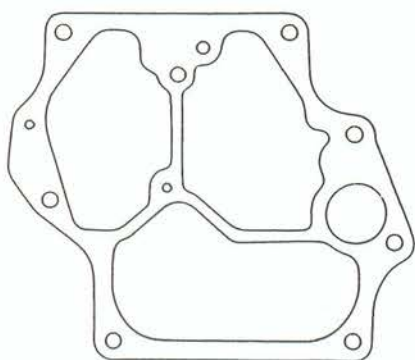

8001
AISAN 2 BBL
Toyota 3/1302

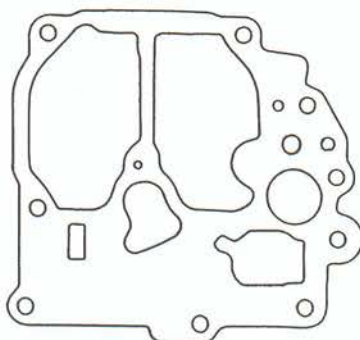

8022
AISAN
Toyota Carina 1600 Hi-Ace
1600 Van - Pick-Up - Hi Lux Pick-Up

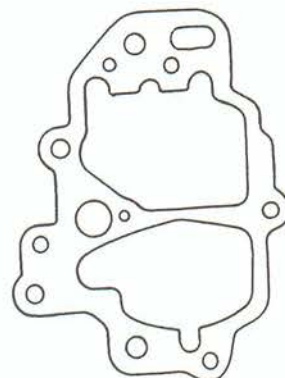

8035
Hitachi - Nikky
Nissan Isuzu

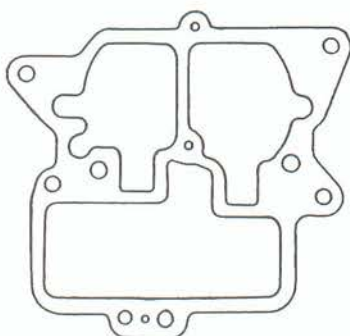

8049
Keihin
Honda - Rover - Triumph

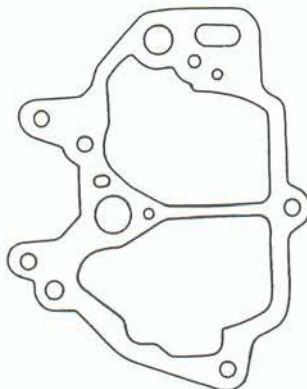

8033
Hitachi - Nikky
Nissan Isuzu

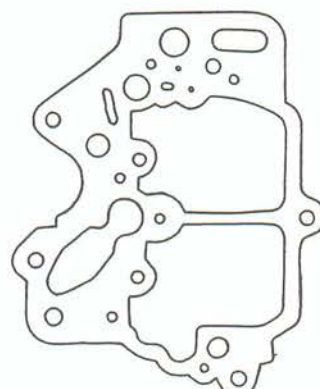

8034
Hitachi - Nikky
Nissan, Isuzu

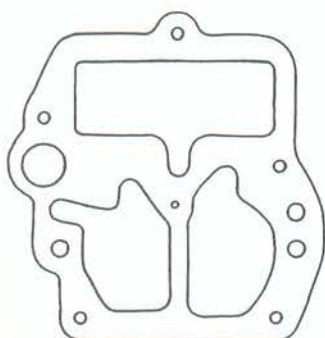

8094
Hitachi
Nissan Micra DX

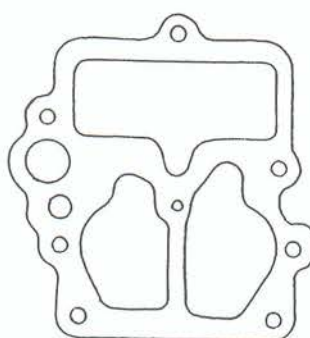

8016
Hitachi
Nissan Micra



8093
Hitachi
Nissan Micra



COPERCHIO CARBURATORE VETTURE GIAPPONESI

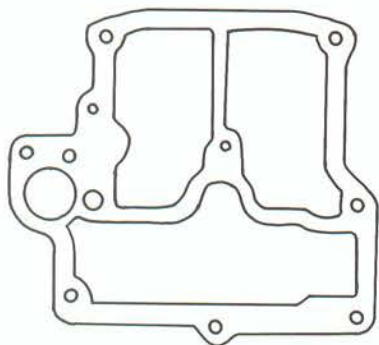

7878
AISAN
Innocenti Minitre

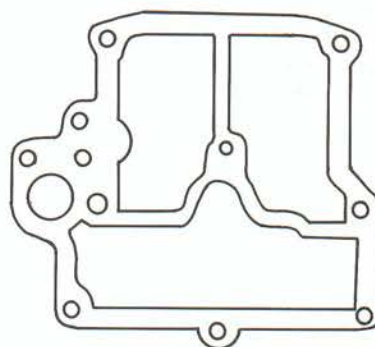

7874
AISAN
Innocenti Minitre

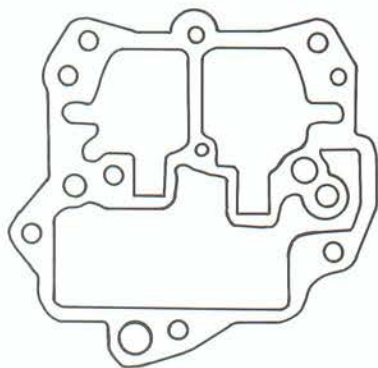

7931
KEIHIN
Audi 80 GL

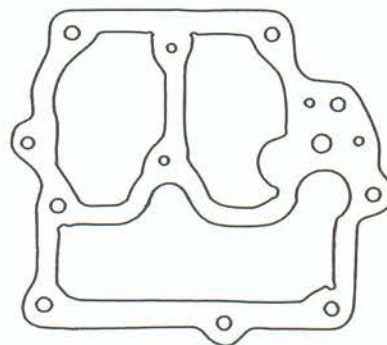

7934
AISAN
Innocenti Minitre

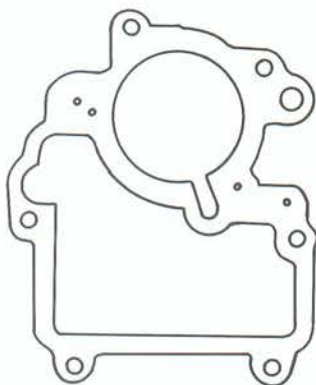

7887
KEIHIN
Zaz 968 M - 968 G 1,2

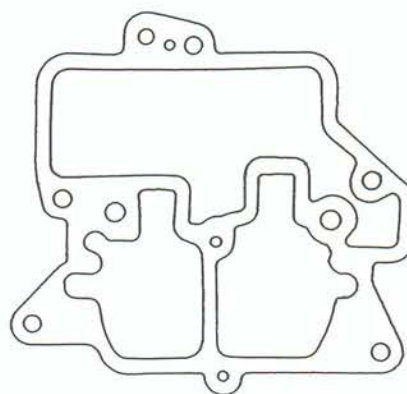

7978
KEIHIN
Audi 80



COPERCHIO CARBURATORE VETTURE GIAPPONESI

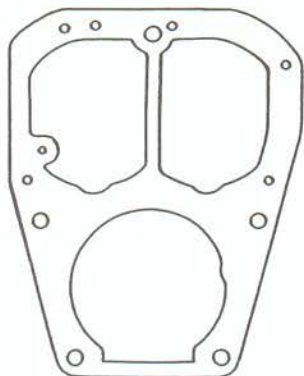

7939

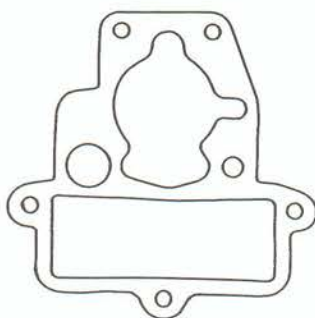

7940

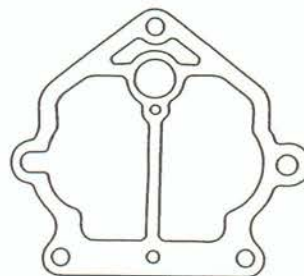

7941
NIKKI
Mazda

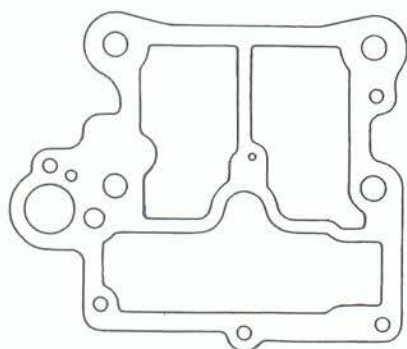

8127
AISAN
Innocenti Minitre

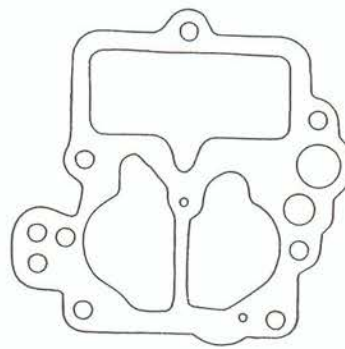

8135
HITACHI 306 DCT
Mazda 323 1500 GT



INTERMEDIE VETTURE GIAPPONESI

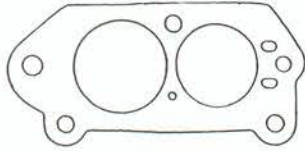

8017
HITACHI
Nissan Micra

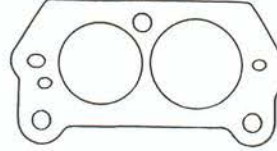

8011
HITACHI
Subaru

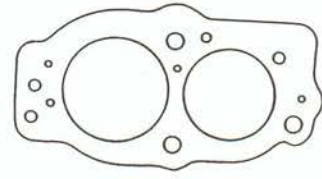

8024
AISAN
Toyota Carina 1600
Hi-Ace 1600 Van - Pick-Up
Hi Lux Pick-Up

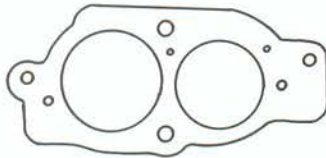

7877
AISAN
Innocenti Minitre

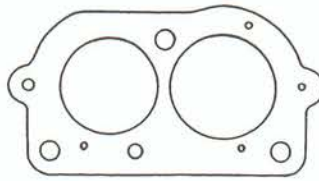

8046
HITACHI - NIKKI
Nissan

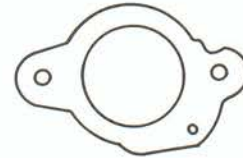

7888
KEIHIN
Zaz

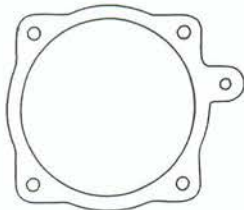

8002
AISAN 2 BBL
Toyota 3/1302

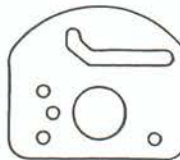

8037
HITACHI - NIKKI
Nissan Isuzu

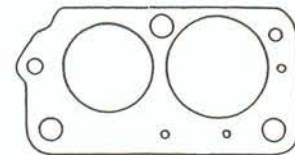

8129
HITACHI - NIKKI
Mazda

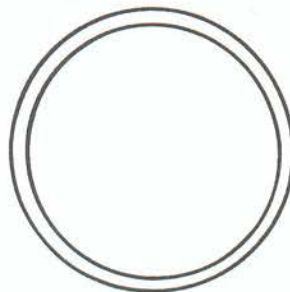

8133
HITACHI - NIKKI
Mazda



ATTACCO CARBURATORE VEETURE GIAPPONESI

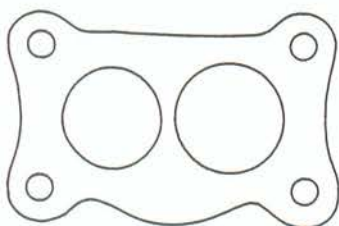

7938
DAIHATSU
Innocenti Mini

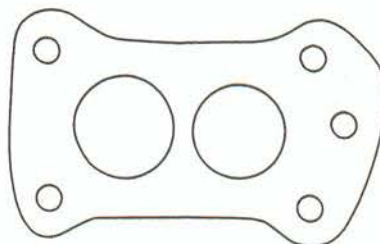

7937
DAIHATSU
Innocenti Mini

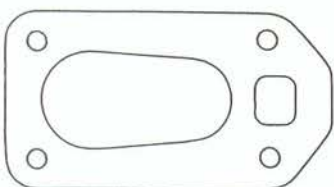

8019
HITACHI - NIKKI
Nissan

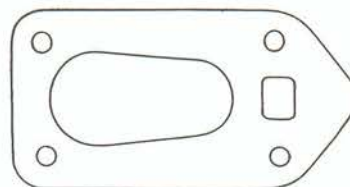

8020
HITACHI - NIKKI
Nissan

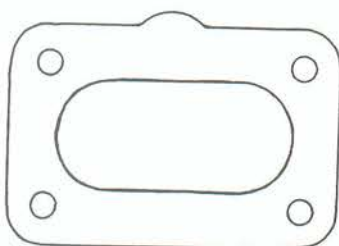

8023
AISAN
Toyota Carina 1600 Hi-Ace
1600 Van - Pick-Up - Hi-Lux Pick-Up

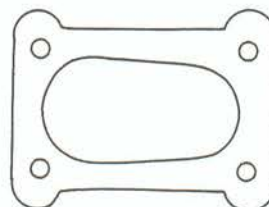

7936
DAIHATSU
Innocenti Mini

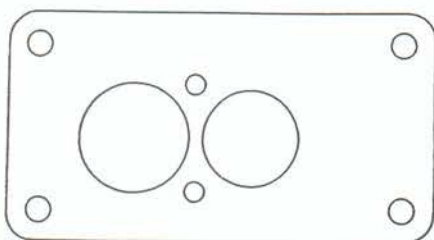

8025
AISAN
Toyota Carina 1600 Hi-Ace
1600 Van - Pick-Up - Hi-Lux Pick-Up

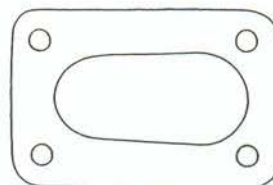

8134
HITACHI 306 DCT
Mazda 323 1500 GT



INTERNE VETTURE GIAPPONESI

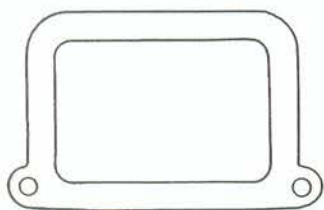

8036

Hitachi - Nikki
Nissan Isuzu



7935

Daihatsu
Innocenti Mini

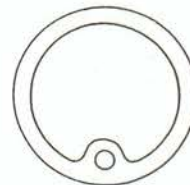

8003

Aisan 2 BBL
Toyota 3/1302

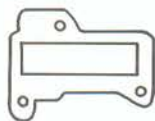

7873

Daihatsu
Innocenti Mini

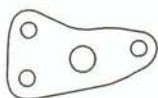

8130

Nikki
Mazda



8131

Nikki
Mazda



8132

Nikki
Mazda

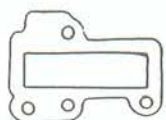

8026

Aisan
Toyota Carina



8027

Aisan
Toyota Carina



7876

Daihatsu
Innocenti Mini



8028

Aisan
Toyota Carina



7875

Daihatsu
Innocenti Mini



8029

Aisan
Toyota Carina

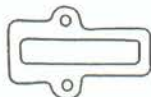

8039

Hitachi - Nikki
Nissan Isuzu

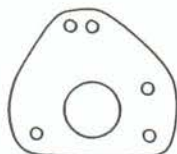

8038

Hitachi - Nikki
Nissan - Isuzu



8040

Hitachi - Nikki
Nissan Isuzu



8041

Hitachi - Nikki
Nissan Isuzu



8042

Hitachi - Nikki
Nissan Isuzu



8044

Hitachi - Nikki
Nissan Isuzu



8043

Hitachi - Nikki
Nissan Isuzu



8047

Hitachi - Nikki
Nissan Datsun



8048

Hitachi - Nikki
Nissan Datsun

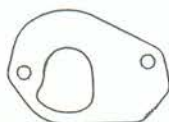

8004

Aisan 2 BBL
Toyota 3/1302



8005

Aisan 2 BBL
Toyota 3/1302



8006

Aisan 2 BBL
Toyota 3/1302



8007

Aisan 2 BBL
Toyota 3/1302



8008

Aisan 2 BBL
Toyota 3/1302



GUARNIZIONI PER IMPIANTI A GAS

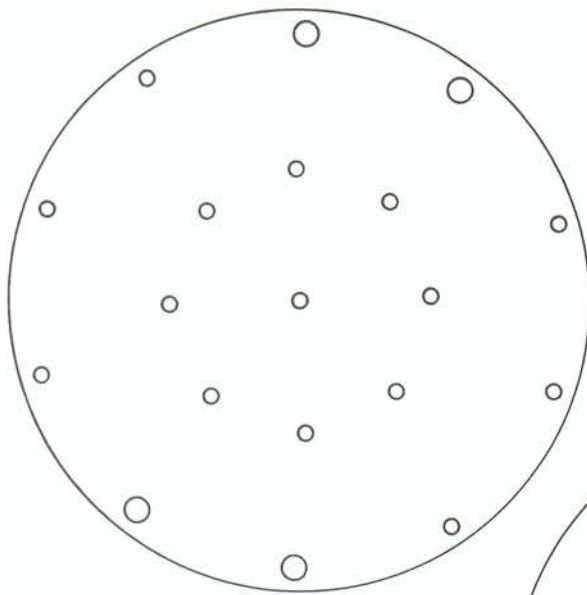

7217
Impianto G.P.L.



7220
Impianto G.P.L.

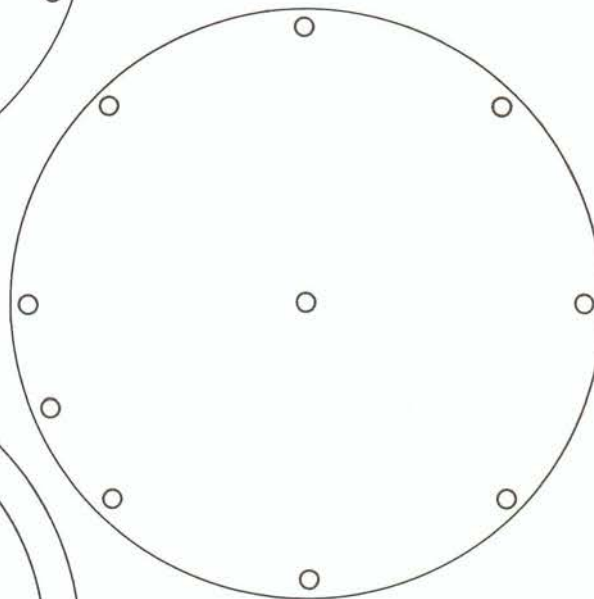

7218
Impianto G.P.L.

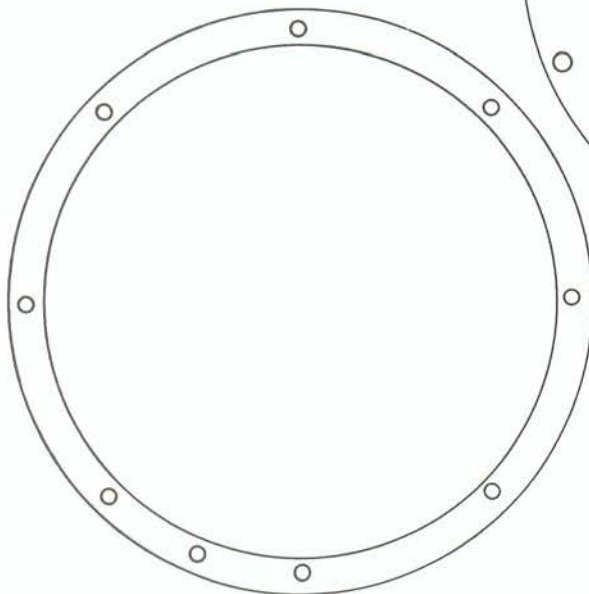

7219
Impianto G.P.L.

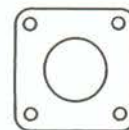

7221
Impianto G.P.L.

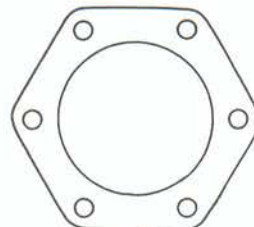

7222
Impianto G.P.L.



GUARNIZIONI PER IMPIANTI A GAS

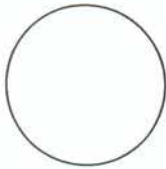

7622
GPL 5 WEBER

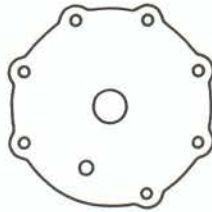

7641
GPL 5 WEBER

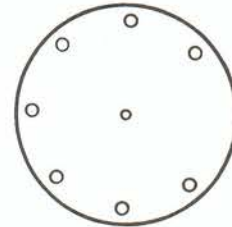

7645
GPL 5 WEBER

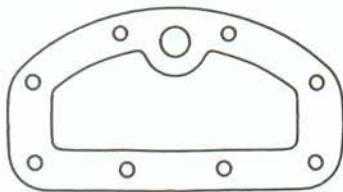

7681
GPL WEBER

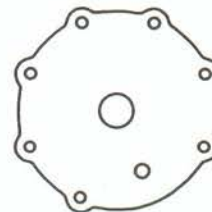

7682
GPL WEBER

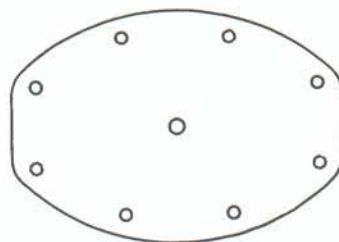

7683
GPL WEBER